

# Viking Lite

*rust and corrosion resistant,  
high reliability with flexible installation*



## **Rust and corrosion resistant designs.**

Viking Lite valves are made of anodized aluminium, for good corrosion resistance. The smooth design, with no dirt-collecting pockets, makes the valve suitable for most environments.

## **High reliability**

Viking Lite valves easily comply with the requirements for the component reliability in accordance with EU Machinery Directive standards EN292-2 and EN983. The valves are designed for use with or without supplementary lubrication.

## **Compact installation dimensions - flexible installation**

Compact dimensions direct body porting and integral mounting holes are all features of the Viking Lite range. In addition to single valve installation, the Viking Lite valves may be installed on manifolds so that the valves have a common supply and manifolded exhausts.

The Viking Lite valve range is robust, versatile and combines high performance with compact installation dimensions. Large flow capacity, short change-over times and low change-over pressure are important characteristics of this valve range.

Designed to operate with pressures up to 10 bar in temperatures -10°C to + 50°C.



- 3 sizes: G1/8, G1/4 and G3/8.
- Large flow capacity with short change-over times.
- Low change over pressure.
- Dynamic bi-directional spool seals.
- Do not require lubrication in operation but can also be installed in systems that are lubricated.

**Operating information**

	<b>P2L-AZ</b>	<b>P2L-BZ</b>	<b>P2L-CZ</b>
Port size:	G1/8	G1/4	G3/8
Working pressure:	10 bar	10 bar	10 bar
Working temperature	-10 °C to +50 °C		
Flow (Qmax);	15,6 l/s	37,8 l/s	68,3 l/s

For more information see [www.parker.com/euro\\_pneumatic](http://www.parker.com/euro_pneumatic)

**Solenoid operated directional control valves**

Internal supply to solenoid valve(s) via port 1.

**3/2 valves, internal air, standard temperature**

Symbol	Size	Actuation	Return	Min Operating Pressure (bar)	Changeover time (ms) at 6 bar @20°C actua./return	Weight Kg	Order code Without coil	Order code With 24V DC (22mm coil)
	G1/8	Electric signal	Electric signal	1,5	10/10	0,18	<b>P2LAZ311EENDCN</b>	<b>P2LAZ311EENDCB49</b>
	G1/4			1,5	12/12	0,18	<b>P2LBZ312EENDCN</b>	<b>P2LBZ312EENDCB49</b>
	G3/8			1,5	17/17	0,36	<b>P2LCZ313EENDCN</b>	<b>P2LCZ313EENDCB49</b>
	G1/8	Electric signal	Spring	3,0	15/35	0,16	<b>P2LAZ311ESNDCN</b>	<b>P2LAZ311ESNDCB49</b>
	G1/4			3,0	18/45	0,16	<b>P2LBZ312ESNDCN</b>	<b>P2LBZ312ESNDCB49</b>
	G3/8			3,0	27/75	0,35	<b>P2LCZ313ESNDCN</b>	<b>P2LCZ313ESNDCB49</b>

**5/2 valves, internal air, standard temperature**

Symbol	Size	Actuation	Return	Min Operating Pressure (bar)	Changeover time (ms) at 6 bar @20°C actua./return	Weight Kg	Order code Without coil	Order code With 24V DC (22mm coil)
	G1/8	Electric signal	Electric signal	1,5	10/10	0,19	<b>P2LAZ511EENDCN</b>	<b>P2LAZ511EENDCB49</b>
	G1/4			1,5	12/12	0,21	<b>P2LBZ512EENDCN</b>	<b>P2LBZ512EENDCB49</b>
	G3/8			1,5	17/17	0,44	<b>P2LCZ513EENDCN</b>	<b>P2LCZ513EENDCB49</b>
	G1/8	Electric signal	Spring	3,0	15/35	0,17	<b>P2LAZ511ESNDCN</b>	<b>P2LAZ511ESNDCB49</b>
	G1/4			3,0	18/45	0,20	<b>P2LBZ512ESNDCN</b>	<b>P2LBZ512ESNDCB49</b>
	G3/8			3,0	27/75	0,43	<b>P2LCZ513ESNDCN</b>	<b>P2LCZ513ESNDCB49</b>

## 5/3 valves, internal air, standard temperature

Symbol	Size	Actuation	Min Operating Pressure (bar)	Changeover time (ms) at 6 bar @20°C actua./return	Weight Kg	Order code Without coil	Order code With 24V DC (22mm coil)
	G1/8	Self centring	3,0	18/40	0,26	<b>P2LAZ611EENDCN</b>	<b>P2LAZ611EENDCB49</b>
	G1/4	Electric/Electric Closed	3,0	22/55	0,28	<b>P2LBZ612EENDCN</b>	<b>P2LBZ612EENDCB49</b>
	G3/8	Centre	3,0	30/90	0,60	<b>P2LCZ613EENDCN</b>	<b>P2LCZ613EENDCB49</b>
	G1/8	Self centring	3,0	18/40	0,26	<b>P2LAZ711EENDCN</b>	<b>P2LAZ711EENDCB49</b>
	G1/4	Electric/Electric Presurised	3,0	22/45	0,28	<b>P2LBZ712EENDCN</b>	<b>P2LBZ712EENDCB49</b>
	G3/8	Centre	3,0	30/90	0,60	<b>P2LCZ713EENDCN</b>	<b>P2LCZ713EENDCB49</b>
	G1/8	Self centring	3,0	18/40	0,26	<b>P2LAZ811EENDCN</b>	<b>P2LAZ811EENDCB49</b>
	G1/4	Electric/Electric Vented	3,0	22/45	0,28	<b>P2LBZ812EENDCN</b>	<b>P2LBZ812EENDCB49</b>
	G3/8	Centre	3,0	30/90	0,60	<b>P2LCZ813EENDCN</b>	<b>P2LCZ813EENDCB49</b>

**Note:** All valves may be ordered with non locking manual override, replacing

...**CN** with ...**BN**

...**CB49** with ...**BB49**

# Viking Lite

Available in boxed quantities of 25



## 5/2 valves, internal air, standard temperature

Size	Actuation	Return	Order code Without solenoid	Order code With 24V DC (22mm coil)
G1/8	Electric	Electric	<b>P2LAZ511EENDCNQ25</b>	<b>P2LAZ511EENDCB49Q25</b>
G1/4	signal	signal	<b>P2LBZ512EENDCNQ25</b>	<b>P2LBZ512EENDCB49Q25</b>
G1/8	Electric	Spring	<b>P2LAZ511ESNDCNQ25</b>	<b>P2LAZ511ESNDCB49Q25</b>
G1/4	signal		<b>P2LBZ512ESNDCNQ25</b>	<b>P2LBZ512ESNDCB49Q25</b>

The Viking Lite valve is available in boxed quantities of 25 combines high performance with compact installation dimensions. Large flow capacity, short change-over times and low change-over pressure are important characteristics of this valve range.

**Dimensions**

**P2LAZ 3/2**  
**Solenoid / Solenoid**

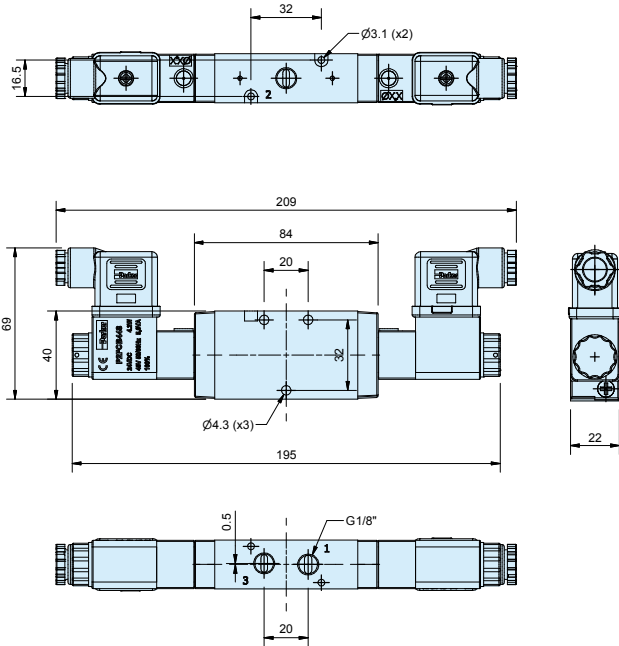

**P2LAZ 3/2**  
**Solenoid / Spring**

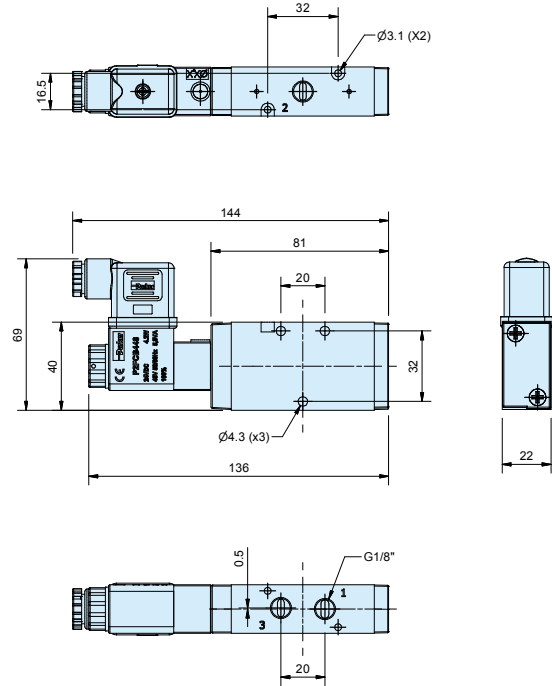

**P2LAZ 5/2 and 5/3**  
**Solenoid / Solenoid**

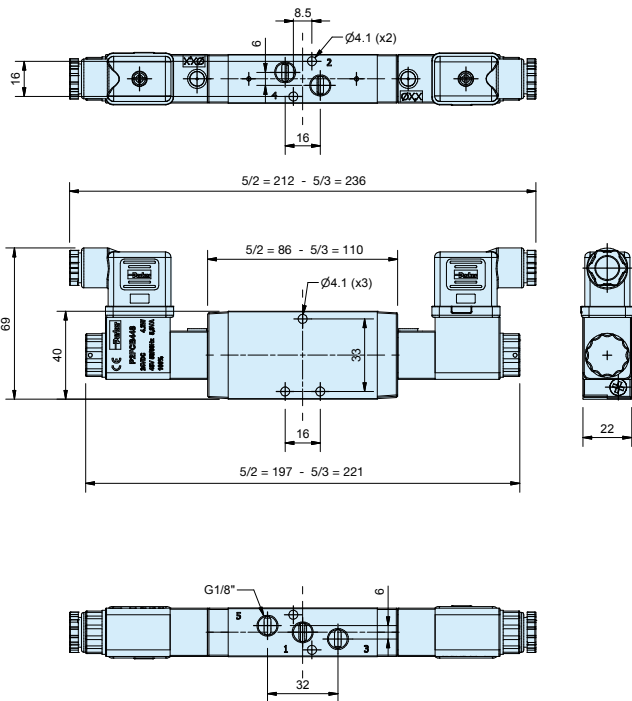

**P2LAZ 5/2**  
**Solenoid / Spring**

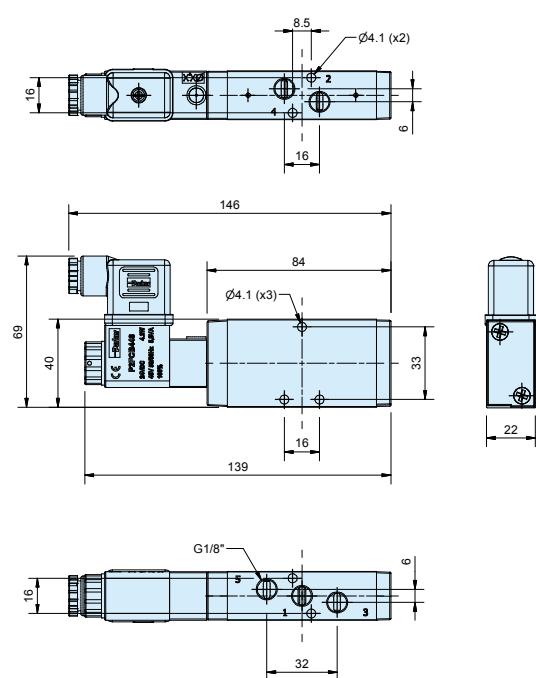

**Solenoid valves**

Solenoid valves and cable plugs must be ordered separately. One pilot valve is required for each E (NDCN only) in the valve order code.

**Dimensions**

**P2LBZ 3/2**  
 Solenoid / Solenoid

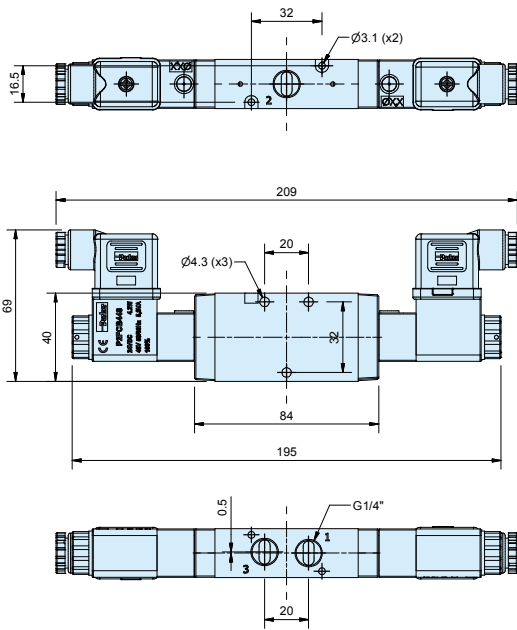

**P2LBZ 3/2**  
 Solenoid / Spring

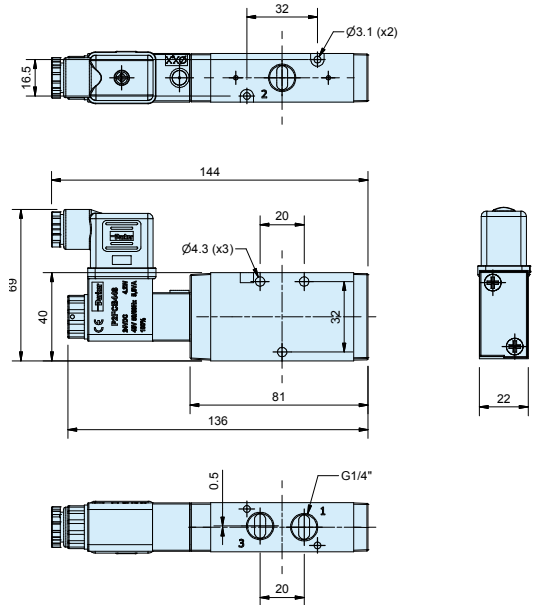

**P2LBZ 5/2 and 5/3**  
 Solenoid / Solenoid

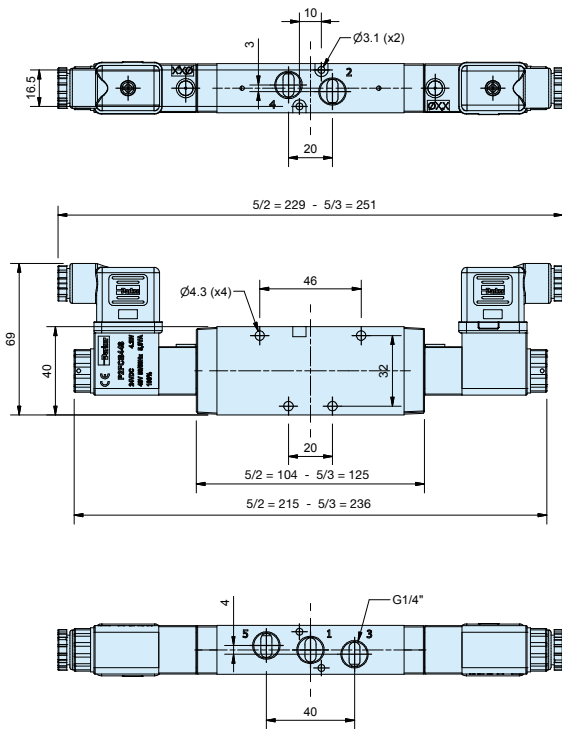

**P2LBZ 5/2**  
 Solenoid / Spring

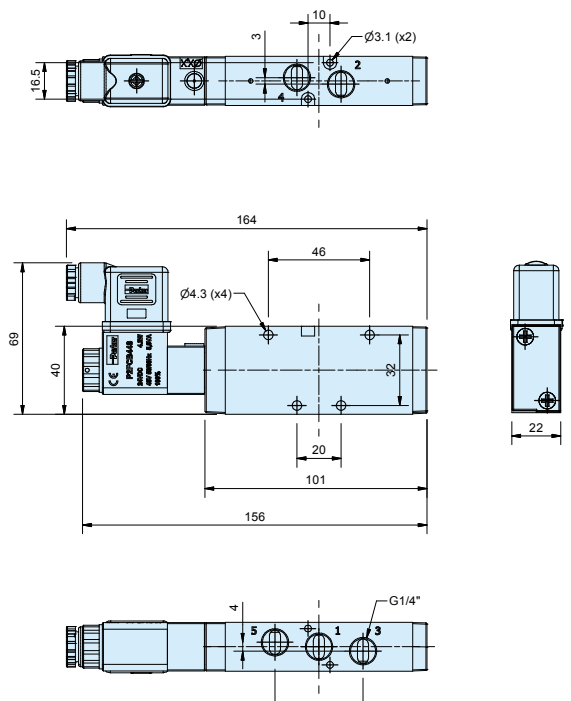

**Solenoid valves**

Solenoid valves and cable plugs must be ordered separately. One pilot valve is required for each E (NDCN only) in the valve order code.

**Dimensions**

**P2LCZ 3/2**  
**Solenoid / Solenoid**

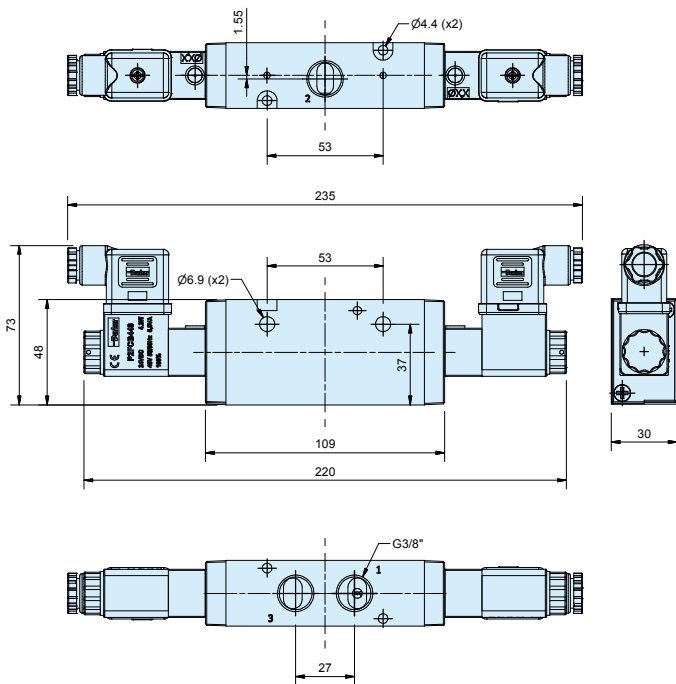

**P2LCZ 3/2**  
**Solenoid / Spring**

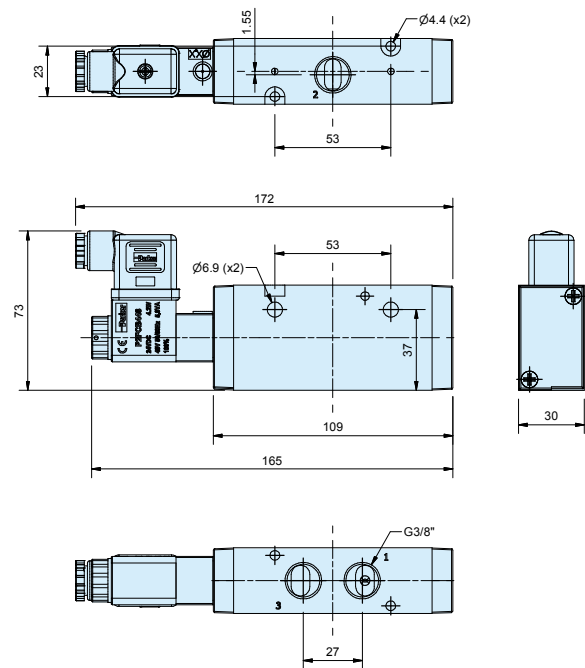

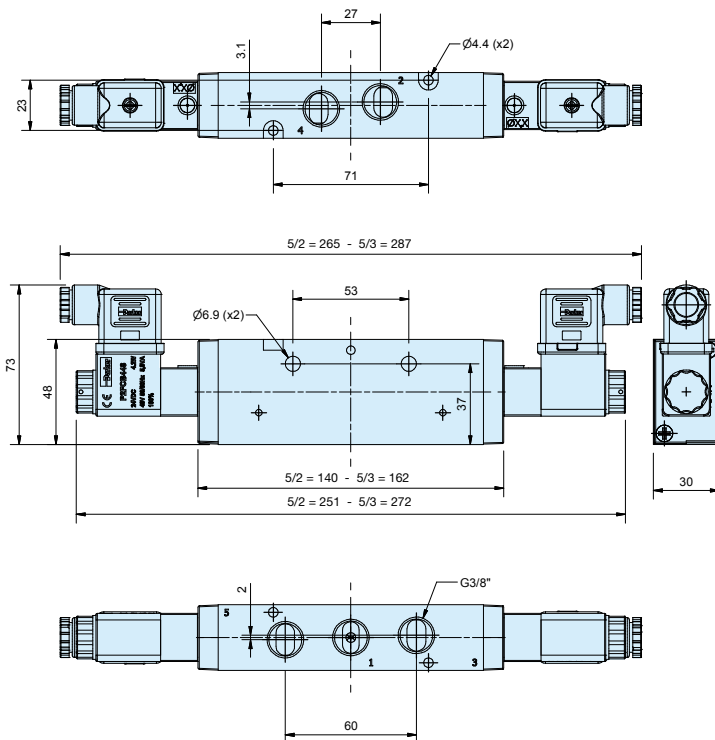

**P2LCZ 5/2 and 5/3**  
**Solenoid / Solenoid**

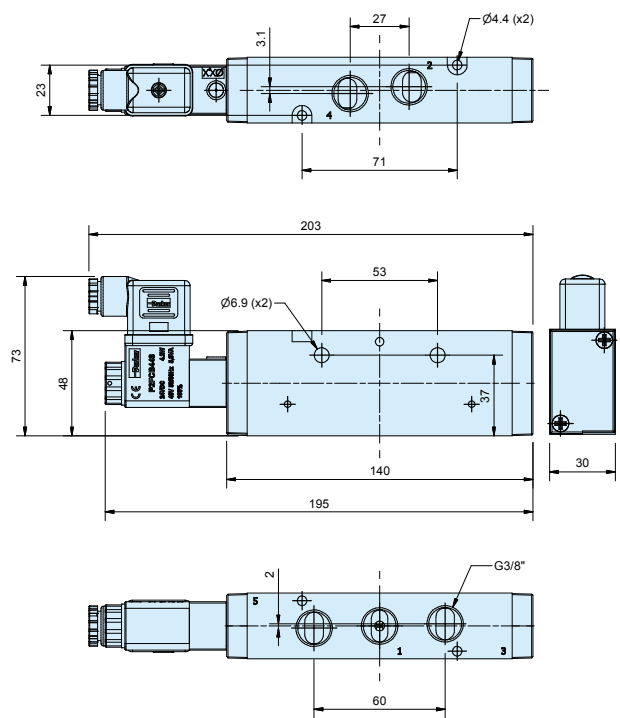

**P2LCZ 5/2**  
**Solenoid / Spring**



Accessories	Type P2LA / P2LB 3/2 valves	Weight kg	Order code
	<b>Manifold bar, P2LB</b> incl. fasteners and O-ring. G3/8		
	For 2 valves	0,38	<b>91213202SXZ</b>
	For 4 valves	0,64	<b>91213204SXZ</b>
	For 6 valves	0,89	<b>91213206SXZ</b>
	For 8 valves	1,15	<b>91213208SXZ</b>
	For 10 valves	1,40	<b>91213210SXZ</b>
	<b>Blanking plate</b> for Manifold bar	0,10	<b>912132BPSXZ</b>

## Dimensions



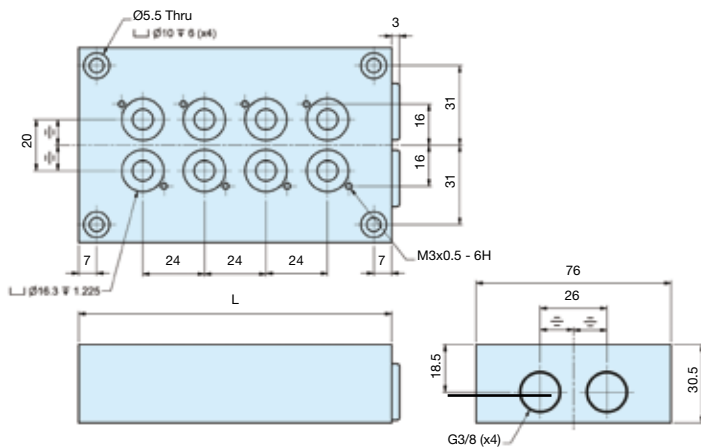



### Manifold bar

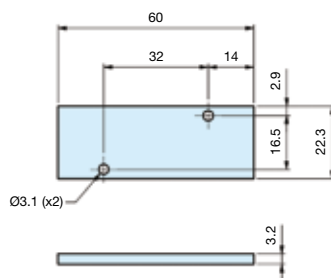

No. of valves	L mm
2	74
4	122
6	170
8	218
10	266

### Blanking plate for manifold bar, P2LB



Accessories	Type P2LA 5/2 valves	Weight kg	Order code
	<b>Manifold bar, P2LA</b> including seals, mounting screws. G3/8 For 4 valves For 6 valves For 8 valves For 10 valves For 12 valves For 14 valves	0,48 0,63 0,80 0,98 1,10 1,23	<b>9121658075</b> <b>9121658076</b> <b>9121658077</b> <b>9121658078</b> <b>9121658079</b> <b>9121658099</b>
	<b>Blanking plate, P2LA</b> for Manifold bar	0,05	<b>9121658063</b>
	<b>Pressure bar, P2LA</b> for common air supply incl. O-rings and mounting screws. G1/4 For 2 valves For 4 valves For 6 valves For 8 valves	0,13 0,20 0,26 0,33	<b>9121658070</b> <b>9121658071</b> <b>9121658072</b> <b>9121658073</b>
	<b>Blanking plate, P2LA</b> for Pressure bar	0,05	<b>9121658074</b>
	<b>Assembly screws, P2LA</b> in stainless steel for valve	0,02	<b>9121658043</b>
	<b>Assembly screws, P2LA</b> in stainless steel for blanking plate	0,01	<b>9121658044</b>
	<b>O-ring kit, P2LA</b> O-rings between valve and manifold bar/Pressure bar	0,01	<b>9121658046</b>

Dimensions

Manifold bar, P2LA

No. of valves	L mm
4	126
6	174
8	222
10	270
12	318
14	366

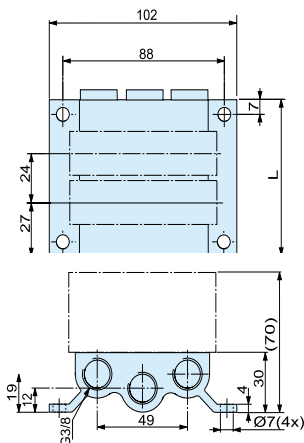

Blanking plate for manifold bar, P2LA

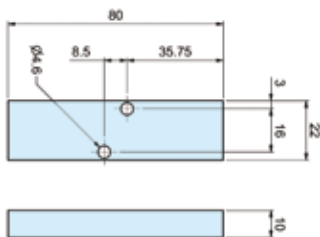

Pressure bar, P2LA

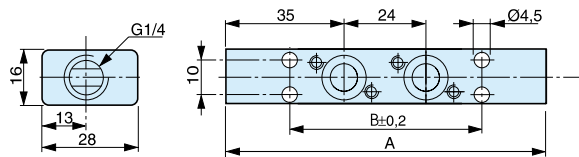



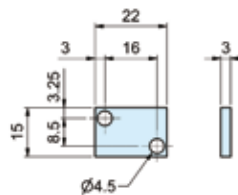

Blanking plate for pressure bar, P2LA



No. of valves	A mm	B mm
2	94	56
4	142	104
6	190	152
8	238	200



Accessories	Type P2LB 5/2 valves	Weight kg	Order code		
	<b>Manifold bar, P2LB</b> incl. fasteners and O-ring. G3/8 For 2 valves For 4 valves For 6 valves For 8 valves For 10 valves	0,69 1,13 1,56 2,00 2,45	<b>9121594805X</b> <b>9121594806X</b> <b>9121594807X</b> <b>9121594808X</b> <b>9121594812X</b>		
		<b>Blanking plate, P2LB</b> for Manifold bar	0,10	<b>9121594809X</b>	
		<b>Pressure bar, P2LB</b> for common air supply incl. O-rings and mounting screws. G3/8 For 2 valves For 4 valves For 6 valves For 8 valves For 10 valves	0,38 0,53 0,68 0,83 0,99	<b>9127113301X</b> <b>9127113302X</b> <b>9127113303X</b> <b>9127113304X</b> <b>9127113305X</b>	
			<b>Blanking plate P2LB</b> for Pressure bar. G1/4	0,02	<b>9127113306X</b>

**Dimensions**

**Manifold bar, P2LB**

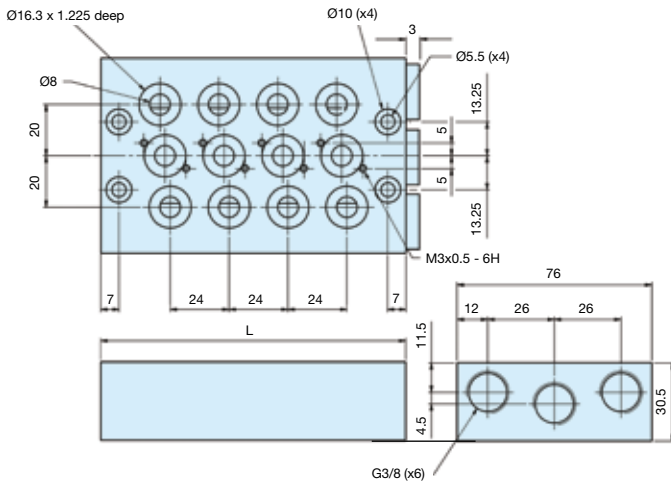

No. of valves	L mm
2	74
4	122
6	170
8	218
10	266

**Blanking plate for manifold bar, P2LB**

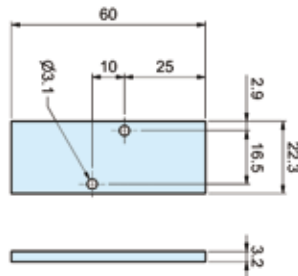

**Pressure bar, P2LB**

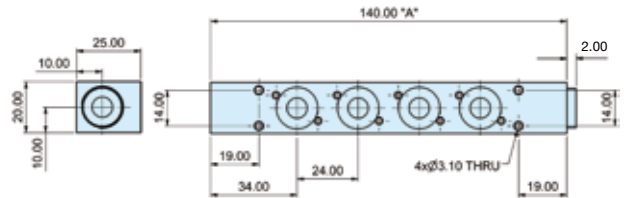

**Blanking plate for pressure bar, P2LB**

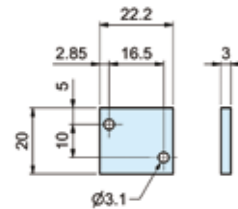

No. of valves	A mm
2	92
4	140
6	188
8	236
10	284

**22mm solenoid operator part numbers and spares**

**Solenoid coils for 22mm solenoid operators**

Voltage	Weight (Kg)	Order code Form B
12V 60Hz	0.093	<b>P2FCB340</b>
24V 50/60Hz	0.093	<b>P2FCB342</b>
12V DC	0.093	<b>P2FCB345</b>
24V DC	0.093	<b>P2FCB349</b>
48V DC	0.093	<b>P2FCB351</b>
110V/50Hz, 120V/60Hz	0.093	<b>P2FCB353</b>
230V/50Hz, 230V/60Hz	0.093	<b>P2FCB357</b>

**Spare Solenoid Nuts**

**Valves requiring captured exhaust should be fitted with plastic knurled nut**

Order code
<b>P2FNP</b>

**Valves with vented exhaust are fitted with diffuser plastic nut**

Order Code
<b>P2FND</b>

**Solenoid Connectors / Cable Plugs EN175301-803**

	Description	Order code 22mm Industrial Form B
With standard screw	Standard IP65 without flying lead	<b>3EV10V10</b>
	With LED and protection 24V AC/DC	<b>3EV10V20-24</b>
	With LED and protection 110V AC	<b>3EV10V20-110</b>
	With LED and protection 230V AC	<b>3EV10V20-230</b>
With cable	24V AC/DC, 5m cable LED and protection IP65	<b>3EV10V20-24L5</b>
	110V AC/DC, 5m cable LED and protection IP65	<b>3EV10V20-110L5</b>
	230V AC, 5m cable LED and protection IP65	<b>3EV10V20-230L5</b>

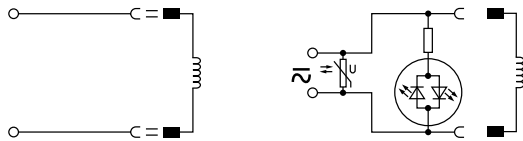

<b>3EV10V10</b>	<b>3EV10V20-24</b>	<b>3EV10V20-24L5</b>
	<b>3EV10V20-110</b>	<b>3EV10V20-110L5</b>
	<b>3EV10V20-230</b>	<b>3EV10V20-230L5</b>

**Cable Plug Dimensions (mm)**

