

Compression Fittings

Brass Compression Fittings

Stainless Steel Compression Fittings

PL Nickel-Plated Brass Spigot Fittings

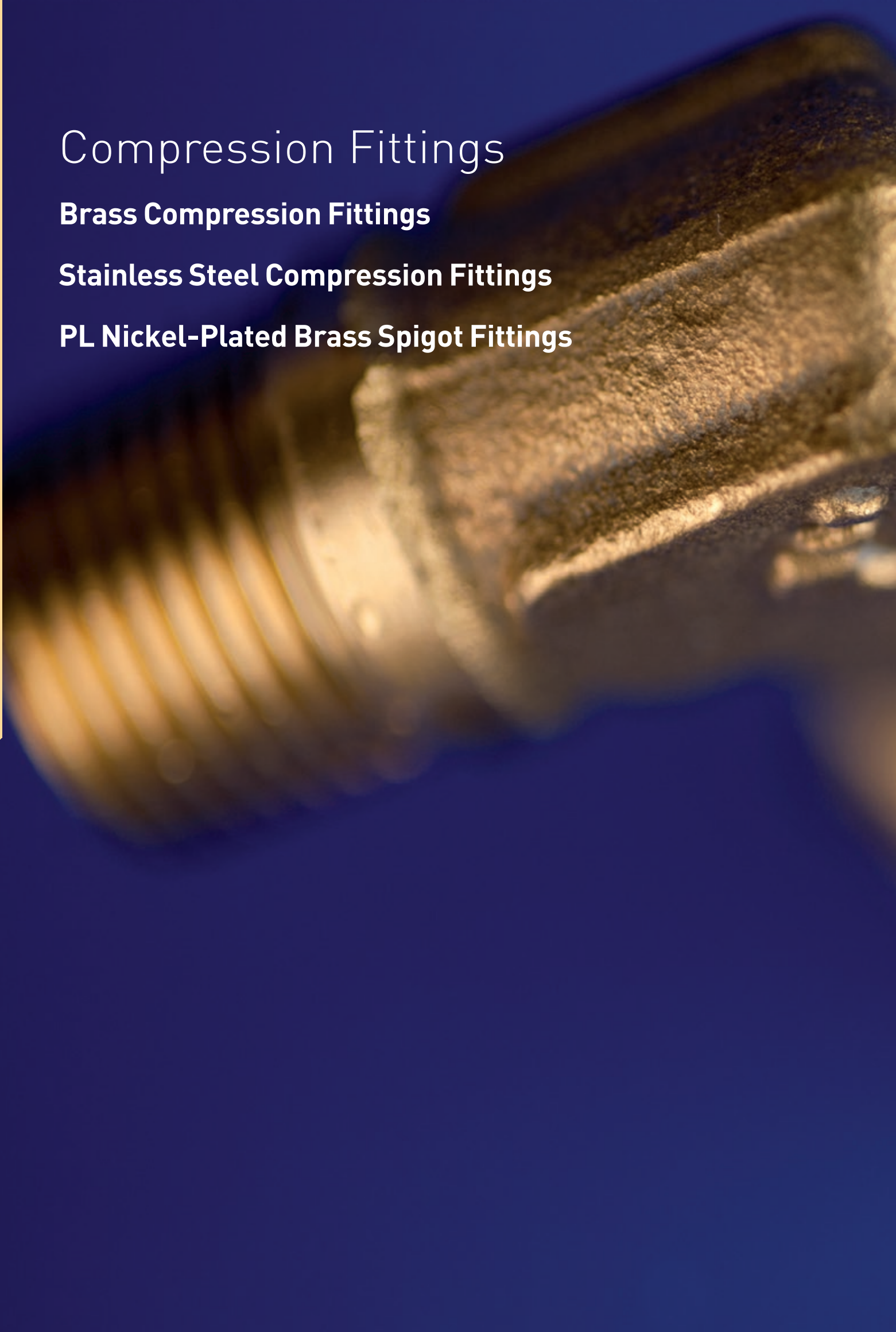



Compression Fittings

Brass Compression Fittings

(P. 5-5)



Fluids: compressed air, non-corrosive industrial fluids

Materials: forged or machined brass

Pressure: 550 bar

Temperature: -60°C to +250°C

Ø metric: 4 mm to 28 mm

Stainless Steel Compression Fittings

(P. 5-31)



Fluids: compressed air, coolants, industrial and corrosive fluids

Materials: 316L stainless steel

Pressure: 400 bar

Temperature: -60°C to +250°C

Ø metric: 6 mm to 16 mm

PL Nickel-Plated Brass Spigot Fittings

(P. 5-41)



Fluids: compressed air, compatible industrial fluids

Materials: forged or machined nickel-plated brass

Pressure: 18 bar

Temperature: -40°C to +100°C

Ø metric: 4 mm to 14 mm

Compression Fitting Part Numbers

0105 14 27 99

Item Type

01XX: brass
18XX: stainless steel

Ø

04 = 4 mm
06 = 6 mm
...
20 = 20 mm
28 = 28 mm

Thread

10 = 1/8
13 = 1/4
...
21 = 1/2
27 = 3/4

Suffix

39: bonded seal
40: treated steel
60: nut
70: polymer nut
99: chemical nickel

PL Fitting Part Numbers

F3BPL 8/10 -1/4

Item Type

FBPL
F3BPL
HBPL
WBPL
...

Ø

2.7/4
4/6
6/8
7.5/10
8/10
10/12
11/14

Thread

BSPT:
1/8
1/4
3/8
...
Metric:
M10
M12

NPT: with adaptor
BSPT and NPT

Related Products

Parker also offers another type of brass compression fitting: **Metrulok**, with a one-piece olive/nut. Do not hesitate to contact us.



Brass Compression Fitting Range

Brass Fittings

Stud Fittings

- | | | | | | | | |
|---------------------------------|--------------------------------|---|--------------------------------------|------------------------------------|----------------------------------|----------------------------------|---------------------------------|
| 0105
BSPT
Page 5-9 | 0105
NPT
Page 5-9 | 0101
BSPP/Metric
Page 5-10 | 0101..39
BSPP
Page 5-10 | 0101
Metric
Page 5-11 | 0114
BSPP
Page 5-11 | 0109
BSPT
Page 5-12 | 0109
NPT
Page 5-12 |
|---------------------------------|--------------------------------|---|--------------------------------------|------------------------------------|----------------------------------|----------------------------------|---------------------------------|



- | | | | | | | |
|----------------------------------|----------------------------------|----------------------------------|----------------------------------|--------------------------------------|----------------------------------|--------------------------------------|
| 0199
BSPP
Page 5-12 | 0108
BSPT
Page 5-13 | 0103
BSPT
Page 5-13 | 0118
BSPP
Page 5-14 | 0118..39
BSPP
Page 5-14 | 0119
BSPP
Page 5-15 | 0119..39
BSPP
Page 5-15 |
|----------------------------------|----------------------------------|----------------------------------|----------------------------------|--------------------------------------|----------------------------------|--------------------------------------|



Tube-to-Tube Fittings

- | | | | | | | |
|--------------------------|--------------------------|--------------------------|--------------------------|--------------------------|--------------------------|--------------------------|
| 0106
Page 5-15 | 0113
Page 5-16 | 0116
Page 5-16 | 0102
Page 5-16 | 0104
Page 5-17 | 0142
Page 5-17 | 0107
Page 5-17 |
|--------------------------|--------------------------|--------------------------|--------------------------|--------------------------|--------------------------|--------------------------|



Complementary Fittings

- | | | | | | | | |
|--------------------------|--------------------------|------------------------------|--------------------------|--------------------------|------------------------------|------------------------------|------------------------------|
| 0166
Page 5-20 | 0124
Page 5-21 | 0124..40
Page 5-21 | 0111
Page 5-21 | 0110
Page 5-22 | 0110..40
Page 5-22 | 0110..60
Page 5-22 | 0110..70
Page 5-22 |
|--------------------------|--------------------------|------------------------------|--------------------------|--------------------------|------------------------------|------------------------------|------------------------------|



Self-Fastening Hose Barb Connectors

- | | | |
|--------------------------|------------------------------|--------------------------|
| 0132
Page 5-25 | 0133..39
Page 5-25 | 0134
Page 5-25 |
|--------------------------|------------------------------|--------------------------|



Accessories

- | | | | | | | | | | | |
|--------------------------|--------------------------|--------------------------|--------------------------|--------------------------|------------------------------|--------------------------|--------------------------|------------------------------|------------------------------|------------------------------|
| 0122
Page 5-26 | 0165
Page 5-26 | 0126
Page 5-27 | 0125
Page 5-27 | 0220
Page 5-27 | 0220..39
Page 5-27 | 0120
Page 5-28 | 0112
Page 5-28 | 0128..39
Page 5-29 | 0151..39
Page 5-29 | 0168..39
Page 5-29 |
|--------------------------|--------------------------|--------------------------|--------------------------|--------------------------|------------------------------|--------------------------|--------------------------|------------------------------|------------------------------|------------------------------|



- | |
|--------------------------|
| 0127
Page 5-30 |
|--------------------------|



Brass Compression Fittings

These **"universal"** fittings provide users with **numerous connection** options for a wide variety of tube materials without the need for tube threading or soldering. This range **guarantees** excellent long-term sealing and performance.

Product Advantages

Simple to Install and Use

- Suitable for pneumatic and medium pressure hydraulic applications
- Compatible with many industrial fluids
- Large product range: 22 configurations
- Excellent sealing due to the tightening of the olive onto the tube
- Metallic sealing guarantees maximum service life
- High strength brass for increased mechanical reliability

Wide Variety of Tubing

- Connection of different types of tubing and hose: metal, polymer, steel, rubber, etc.
- Multiple tube diameters can be connected using the Parker Legris reducer assembly system
- No insert required for rigid and semi-rigid polyamide tubing below 14 mm



- Applications**
- Pneumatics
 - Cooling
 - Automotive Process
 - Lubrication
 - Fluid Transmission
 - Packaging
 - Industrial Machinery

Technical Characteristics

Compatible Fluids	Water, machining oil, fuel, hydraulic oil, compressed air, chemical fluids, disinfectants
Working Pressure	Vacuum to 550 bar
Working Temperature	-60°C to +250°C without sealing washer, with metal tubing
Tightening Torque	See "Technical Characteristics" on opposite page

Working temperature: -20°C to +100°C, with sealing washer and polyamide tubing. Reliable performance is dependent upon the type of fluid conveyed, component materials and tubing being used. Guaranteed for use with a vacuum of 755 mm Hg (99% vacuum). Thread sealing must be guaranteed by user.

Component Materials

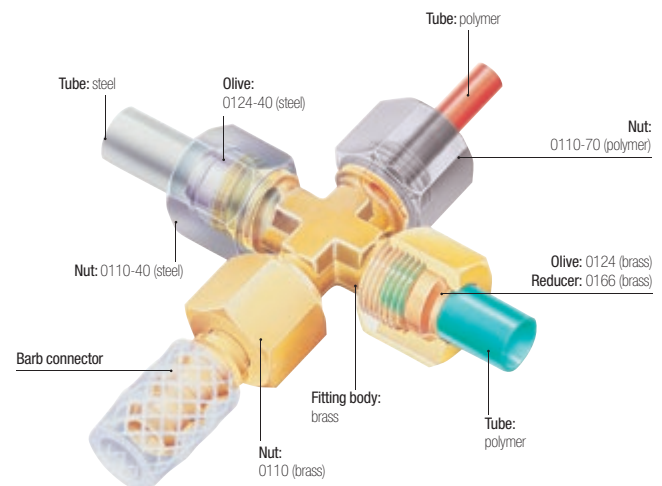

Maximum Bore Diameters

The table below shows the recommended compatibility of tube size, BSPP male thread and maximum bore.

Tube O.D.	BSPP Thread	Max. Bore
4-5-6	G1/8	4
6-8-10	G1/4	7
10-12-14	G3/8	11
14-15-16-18	G1/2	14
18-20-22	G3/4	18
22-25-28	G1	24

Tube Length for Assembly

Minimum length of tube (L) between 2 fittings.



ØD	L (mm)	ØD	L (mm)	ØD	L (mm)
4	26.5	12	39	20	51
5	26	14	41	22	54
6	26	15	41	25	62
8	32	16	46.5	28	62
10	39	18	49.5		

Regulations

CNOMO: E07.21.115N (for robotic equipment in the automotive industry)

DI: 97/23/EC (PED)

RG: 1907/2006 (REACH)

DI: 2002/95/EC (RoHS)

DI: 94/9/EC (ATEX)

Technical Characteristics

Installing Compression Fittings

Cutting the Tube



Cut the polymer or metal tube square.

Preparing the Connection



For metal tubing, de-burr the tube prior to connection. Tube bending should be done before connection.



Slide the nut onto the tube; lubricate the threads on the body and nut along with the olive to facilitate tightening (for metal tubing as well). Fit the olive onto the end of the tube.

Connecting the Tube



Push the tube up against the shoulder of the body of the fitting and hand tighten.

Final Assembly



Tighten the nut using a spanner or torque wrench to enable the olive to bite on the tube, the connection being completed when the recommended tightening torque is reached (see tables below).



It is recommended to use an insert in order to prevent tube creeping (diameter > 14mm)

Recommended Nut Tightening Torque

Tightening torque in daN.m = maximum tightening torque of a 0110 nut and 0124 olive with copper, brass or steel tube.

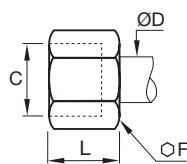

Nut 0110 and 0110..40

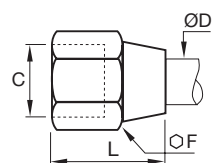

Nut 0110..60

Ø D (mm)	Ø F 0110	Ø F 0110..60	Max. daN.m Copper or Brass	Ø F 0110..40	Max. daN.m Steel
4	10	11	0.7	10	1.5
5	12	13	0.7	12	1.5
6	13	13	1.5	13	2.5
8	14	16	1.5	14	2.5
10	19	20	1.8	19	3
12	22	22	3	22	4.5
14	24	24	3.5	24	5.5
15	24	24	4	24	6
16	27	27	5	27	7
18	30	30	6	30	9
20	32	32	6	32	10
22	36	36	7	36	12
25	41	41	8	41	13
28	42		9		

Customised Fittings

Working directly with its customers and based on its knowledge and experience, Parker Legris can design customised brass compression fittings for specific requirements using the customer's specifications.

The range of compression fittings also offers nickel chemical surface treatment in order to improve the corrosion resistance and chemical compatibility of the fittings (the model number of the fitting is then given the suffix 99).

The above recommendations are given in good faith. However, since each application is different, it is advisable to undertake tests in actual working conditions.



Technical Characteristics

The use of Parker Legris brass compression fittings is dependant on the tube material. Tables of recommended working pressure for the different tubes are shown below.

Recommended Tube Type

Copper tube: copper which has been "cold rolled", cold drawn and in straight lengths.

Brass tube: in cold-rolled straight lengths (same working pressure as for copper tube).

"Coiled annealed" copper tube: reduces working pressure by 35%; must be avoided completely if vibration is present.

Steel tube: "thin wall" cold drawn, seamless, bright annealed and in straight lengths. 6 mm to 16 mm O.D.: max. wall thickness 1 mm. Above 16 mm O.D.: max. wall thickness 1.5 mm

Polyamide tube: semi-rigid. For rigid polyamide tube, multiply the figures in this table by 1.8.

Recommended Tube-Fitting Assembly Configurations

Assembled using Parker Legris brass olive and nut.

Assembled using Parker Legris steel olive and nut (nut type O110..40).

Assembled using Parker Legris brass olive and nut.

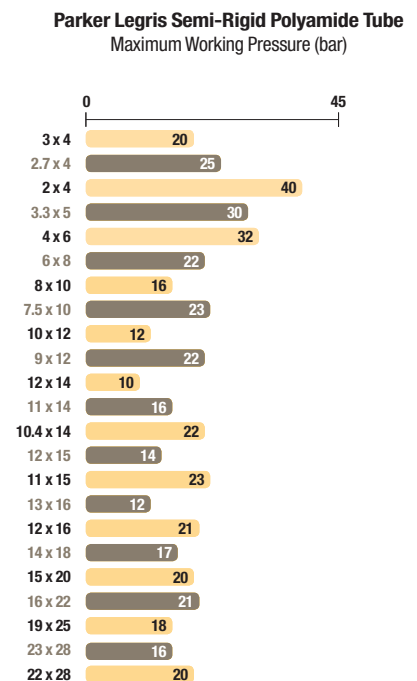
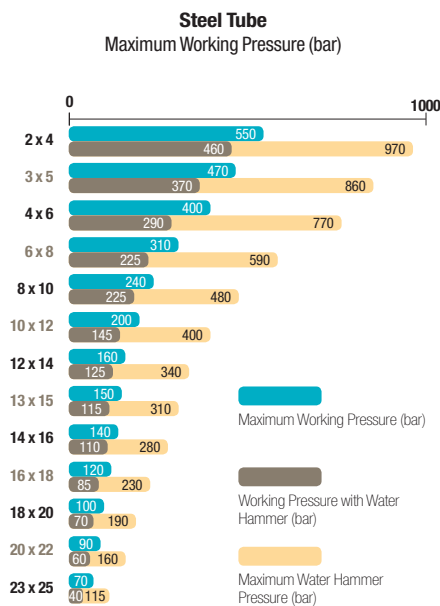
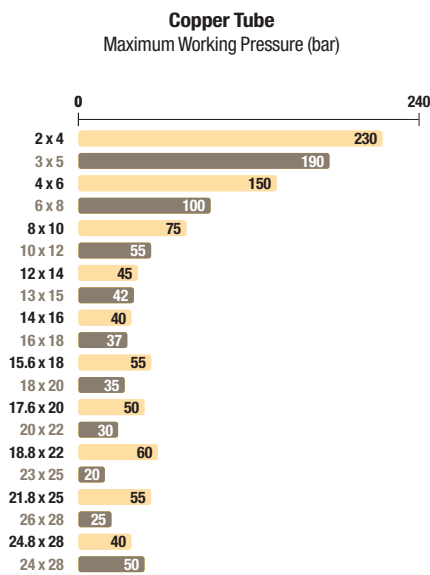

When using a plastic nut type O110..70, the maximum working pressure is 10 bar, for all diameters.

Working Pressure Coefficients for Semi-Rigid Polyamide Tubing

Temperature °C	-40°C / -15°C	-15°C / +30°C	+30°C / +50°C	+50°C / +70°C	+70°C / +100°C
Factor	1.8	1	0.68	0.55	0.31

Parker Legris brass compression fittings are not compatible with ammonia and its derivatives.

The above recommendations are given in good faith. However, since each application is different, it is advisable to undertake tests in actual working conditions.

Brass Compression Fittings

0105 Stud Fitting, Male BSPT Thread

Brass

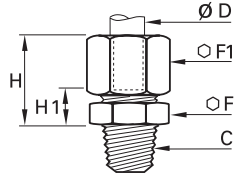

ØD	C		F	F1	H max	H1	Kg
4	R1/8	0105 04 10	10	10	17	7	0.012
	R1/8	0105 05 10	11	12	17.5	7.5	0.016
5	R1/4	0105 05 13	14	12	17.5	7.5	0.023
	R1/8	0105 06 10	11	13	18	7.5	0.017
6	R1/4	0105 06 13	14	13	18	7.5	0.024
	R3/8	0105 06 17	17	13	18	8.5	0.030
	R1/8	0105 08 10	13	14	19.5	7	0.020
8	R1/4	0105 08 13	14	14	19.5	7	0.025
	R3/8	0105 08 17	17	14	20.5	8	0.032
	R1/8	0105 10 10	17	19	24	9	0.042
10	R1/4	0105 10 13	17	19	24	9	0.047
	R3/8	0105 10 17	17	19	24	9	0.048
	R1/2	0105 10 21	22	19	25	10	0.066
12	R1/4	0105 12 13	19	22	24	9	0.059
	R3/8	0105 12 17	19	22	24	9	0.060
	R1/2	0105 12 21	22	22	25	10	0.076
14	R1/4	0105 14 13	22	24	25	8	0.067
	R3/8	0105 14 17	22	24	25	8	0.068
	R1/2	0105 14 21	22	24	26	9	0.080
15	R3/4	0105 14 27	27	24	27	10	0.107
	R3/8	0105 15 17	22	24	25	8	0.066
	R1/2	0105 15 21	22	24	26	9	0.077
16	R1/4	0105 16 13	24	27	27	9.5	0.090
	R3/8	0105 16 17	24	27	27	9.5	0.092
	R1/2	0105 16 21	24	27	27	9.5	0.099
	R3/4	0105 16 27	27	27	28	10.5	0.119
18	R1/2	0105 18 21	27	30	30	10.5	0.125
	R3/4	0105 18 27	27	30	30	10.5	0.137
20	R1/2	0105 20 21	30	32	32	11	0.146
	R3/4	0105 20 27	30	32	32	11	0.157
22	R1/2	0105 22 21	32	36	33	11	0.188
	R3/4	0105 22 27	32	36	33	11	0.197
	R1	0105 22 34	36	36	33	11	0.225
25	R3/4	0105 25 27	36	41	36	11	0.263
	R1	0105 25 34	36	41	36	11	0.277
28	R3/4	0105 28 27	41	42	36	11	0.273
	R1	0105 28 34	41	42	36	11	0.284

Metric taper threads or NPT threads are available by special order, subject to minimum quantities.

0105 Stud Fitting, Male NPT Thread

Brass

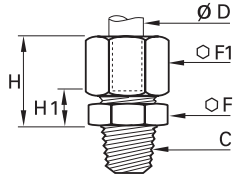

ØD	C		F	F1	H max	H1	Kg
6	NPT1/8	0105 06 11	11	13	18	7.5	0.018
	NPT1/4	0105 06 14	14	13	18	7.5	0.027
8	NPT1/8	0105 08 11	13	14	21	7	0.021
	NPT1/4	0105 08 14	14	14	18.5	7	0.026
10	NPT1/4	0105 10 14	17	19	24	9	0.047
	NPT3/8	0105 10 18	17	19	24	9	0.047
	NPT1/2	0105 10 22	22	19	25	10	0.066

Related Products

Parker also offers another type of brass compression fitting: **Metrolok**, with a one-piece olive/nut.

Do not hesitate to contact us.



Brass Compression Fittings

0101 Stud Fitting with Captive Sealing Washer, Male BSPP and Metric Thread

Brass, technical polymer

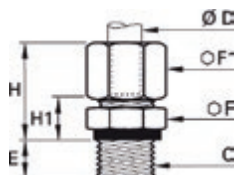

ØD	C		E	F	F1	H _{max}	H1	Kg
4	M5x0.8	0101 04 19	5	10	10	16.5	8	0.011
	G1/8	0101 04 10	6.5	13	10	16.5	8	0.016
5	G1/8	0101 05 10	6.5	13	12	17.5	8.5	0.018
	G1/8	0101 06 10	6.5	13	13	18	8.5	0.020
6	G1/4	0101 06 13	8	17	13	18	9.5	0.030
	G1/8	0101 08 10	6.5	13	14	19	8.5	0.021
8	G1/4	0101 08 13	8	17	14	19.5	9	0.031
	G3/8	0101 08 17	11	22	14	20	10.5	0.044
10	G1/4	0101 10 13	8	17	19	24	11	0.048
	G3/8	0101 10 17	11	22	19	24	11.5	0.061
12	G1/4	0101 12 13	8	19	22	24	11	0.062
	G3/8	0101 12 17	11	22	22	24	11.5	0.070
14	G1/2	0101 12 21	12	27	22	24	12	0.089
	G3/8	0101 14 17	11	22	24	25	10.5	0.074
15	G1/2	0101 14 21	12	27	24	25	11	0.093
	G3/8	0101 15 17	11	22	24	25	10.5	0.071
16	G1/2	0101 15 21	12	27	24	25	11	0.094
	G3/8	0101 16 17	11	22	27	27	12	0.091
18	G1/2	0101 16 21	12	27	27	27	12.5	0.109
	G1/2	0101 18 21	12	27	30	29.5	12.5	0.128
20	G3/4	0101 18 27	13	32	30	29.5	13	0.152
	G3/4	0101 20 27	13	32	32	31	13	0.164
22	G3/4	0101 22 27	13	32	36	32	13	0.194
	G1	0101 22 34	15	41	36	31	13.5	0.259
25	G3/4	0101 25 27	13	36	41	35.5	13	0.260
	G1	0101 25 34	15	41	41	35.5	13	0.306
28	G1	0101 28 34	15	41	42	35.5	13.5	0.299

With pre-assembled polyamide washer
Sealing washers 0602 can be found in chapter 9.

0101..39 Stud Fitting, with Bi-Material Seal, Male BSPP Thread

Brass, zinc-plated steel with NBR seal

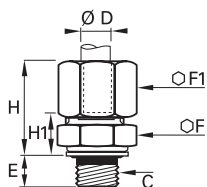

ØD	C		E	F	F1	H _{max}	H1	Kg
4	G1/8	0101 04 10 39	5.5	13	10	17.5	9	0.016
5	G1/8	0101 05 10 39	5.5	13	12	18.5	9.5	0.019
	G1/8	0101 06 10 39	5.5	13	13	19	9.5	0.020
6	G1/4	0101 06 13 39	7	17	13	19	10.5	0.030
	G1/8	0101 08 10 39	5.5	13	14	20	9.5	0.022
8	G1/4	0101 08 13 39	7	17	14	20.5	10	0.031
	G3/8	0101 08 17 39	9.5	22	14	21.5	12	0.045
10	G1/4	0101 10 13 39	7	17	19	25	12	0.048
	G3/8	0101 10 17 39	9.5	22	19	25.5	13	0.061
12	G1/4	0101 12 13 39	7	19	22	25	12	0.062
	G3/8	0101 12 17 39	9.5	22	22	25	13	0.070
14	G1/2	0101 12 21 39	10.5	27	22	25	13.5	0.090
	G3/8	0101 14 17 39	9.5	22	24	26.5	12	0.076
15	G1/2	0101 14 21 39	10.5	27	24	26.5	12.5	0.094
	G3/8	0101 15 17 39	9.5	22	24	26.5	12	0.071
16	G1/2	0101 15 21 39	10.5	27	24	26.5	12.5	0.094
	G3/8	0101 16 17 39	9.5	22	27	28.5	13.5	0.092
18	G1/2	0101 16 21 39	10.5	27	27	28.5	14	0.109
	G1/2	0101 18 21 39	10.5	27	30	31	14	0.129
20	G3/4	0101 18 27 39	11.5	32	30	31	14.5	0.154
	G3/4	0101 20 27 39	11.5	32	32	32.5	14.5	0.167
22	G3/4	0101 22 27 39	11.5	32	36	32.5	14.5	0.197
	G1	0101 22 34 39	13	41	36	33	15.5	0.259
25	G1	0101 25 34 39	13	41	41	37.5	15.5	0.309
28	G1	0101 28 34 39	13	41	42	37.5	15.5	0.300

Thread with bi-material seal
Bi-material sealing washers, part number 0139, can be found in Chapter 9

Brass Compression Fittings

0101 Stud Fitting, Male Metric Thread

Brass

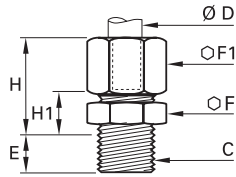

ØD	C		E	F	F1	H _{max}	H1	Kg
4	M7x1	0101 04 55	6.5	10	10	16.5	7.5	0.012
	M8x1	0101 04 56	6.5	11	10	16.5	7.5	0.013
5	M8x1	0101 05 56	6.5	11	12	17.5	8	0.015
	M10x1	0101 05 60	6.5	14	12	17.5	8.5	0.020
6	M10x1	0101 06 60	6.5	14	13	18	8.5	0.021
	M10x1.5	0101 06 62	6.5	14	13	18	8.5	0.021
8	M12x1	0101 08 65	8	17	14	19.5	9	0.029
	M12x1.25	0101 08 66	8	17	14	19.5	9	0.029
	M13x1.25	0101 08 68	8	17	14	19.5	9	0.030
10	M14x1.25	0101 10 70	8	17	19	24	11	0.048
	M14x1.5	0101 10 71	8	17	19	24	11	0.047
	M16x1.25	0101 10 74	9	19	19	24	11	0.051
12	M16x1.5	0101 10 75	9	19	19	24	11	0.051
	M18x1.5	0101 10 78	9	22	19	24	11.5	0.060
	M16x1.25	0101 12 74	9	19	22	24	11	0.061
14	M16x1.5	0101 12 75	9	19	22	24	11	0.061
	M18x1.5	0101 12 78	9	22	22	24	11.5	0.071
15	M18x1.5	0101 14 78	9	22	24	25	10.5	0.071
	M20x1.5	0101 14 80	10	24	24	25	11	0.084
16	M18x1.5	0101 15 78	9	22	24	25	10.5	0.071
	M20x1.5	0101 16 80	10	24	27	27	12.5	0.101
18	M22x1.5	0101 16 82	10	27	27	27	12.5	0.110
	M22x1.5	0101 18 82	10	27	30	29.5	12.5	0.129
	M24x1.5	0101 18 83	11	30	30	29.5	13	0.142

0114 Stud Fitting, Female BSPP Thread

Brass

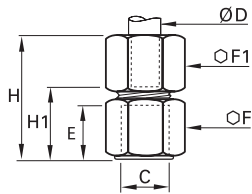

ØD	C		E	F	F1	H _{max}	H1	Kg
4	G1/8	0114 04 10	9.5	14	10	26	16.5	0.020
	G1/4	0114 04 13	13.5	17	10	30	20.5	0.030
5	G1/8	0114 05 10	9.5	14	12	28	17	0.023
	G1/4	0114 05 13	13.5	17	12	31	21	0.033
6	G1/8	0114 06 10	9.5	14	13	28	17	0.025
	G1/4	0114 06 13	13.5	17	13	32	21	0.034
8	G3/8	0114 06 17	14	22	13	32	21.5	0.051
	G1/8	0114 08 10	9.5	14	14	29	16.5	0.026
	G1/4	0114 08 13	13.5	17	14	33	20.5	0.035
10	G3/8	0114 08 17	14	22	14	34	21	0.052
	G1/4	0114 10 13	13.5	17	19	37	21.5	0.052
	G3/8	0114 10 17	14	22	19	37	22	0.068
12	G1/2	0114 10 21	18.5	27	19	42	26.5	0.100
	G1/4	0114 12 13	13.5	19	22	36	20.5	0.068
	G3/8	0114 12 17	14	22	22	37	22	0.078
14	G1/2	0114 12 21	18.5	27	22	42	26.5	0.109
	G1/4	0114 14 13	13.5	22	24	36	18.5	0.085
	G3/8	0114 14 17	14	22	24	38	21	0.048
15	G1/2	0114 14 21	18.5	27	24	43	25.5	0.112
	G3/8	0114 15 17	14	22	24	38	21	0.078
	G1/2	0114 15 21	18.5	27	24	43	25.5	0.109
16	G1/4	0114 16 13	13.5	24	27	36	18	0.107
	G3/8	0114 16 17	14	24	27	38	20.5	0.106
	G1/2	0114 16 21	18.5	27	27	44	26	0.128
18	G3/8	0114 18 17	14	27	30	39	19.5	0.140
	G1/2	0114 18 21	18.5	27	30	45	26	0.144
	G3/4	0114 18 27	19.5	32	30	46	27	0.164
20	G3/8	0114 20 17	14	30	32	38	18	0.161
	G1/2	0114 20 21	18.5	30	32	44.5	24	0.171
22	G3/4	0114 20 27	19.5	32	32	47	26.5	0.171
	G3/4	0114 22 27	19.5	32	36	48	26.5	0.203
25	G3/4	0114 25 27	19.5	36	41	50.5	26	0.297

Brass Compression Fittings

Compression Fittings

Brass Compression Fittings

0109 Stud Elbow, Male BSPT Thread

Brass

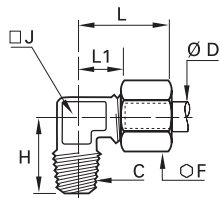

ØD	C		F	H	J	L _{max}	L1	Kg
4	R1/8	0109 04 10	10	17	8	19	9.5	0.016
	R1/4	0109 04 13	10	20	10	19	11	0.024
5	R1/8	0109 05 10	12	17.5	8	21	11	0.019
	R1/4	0109 05 13	12	21.5	10	22	12	0.029
6	R1/8	0109 06 10	13	18	8	22	11	0.021
	R1/4	0109 06 13	13	21.5	10	22	12	0.030
8	R1/8	0109 08 10	14	18.5	10	28	15	0.028
	R1/4	0109 08 13	14	22	10	28	15	0.034
	R3/8	0109 08 17	14	24	12	28	15	0.043
10	R1/4	0109 10 13	19	25	12	30	14.5	0.053
	R3/8	0109 10 17	19	25.5	12	30	14.5	0.059
	R1/2	0109 10 21	19	32	19	36	21	0.108
12	R1/4	0109 12 13	22	26	15	30	15	0.074
	R3/8	0109 12 17	22	27	15	30	15	0.077
	R1/2	0109 12 21	22	32	19	36	21	0.114
14	R3/8	0109 14 17	24	30	19	35	18	0.105
	R1/2	0109 14 21	24	32	19	35	18	0.111
15	R3/8	0109 15 17	24	30	19	35	18	0.100
	R1/2	0109 15 21	24	32	19	35	18	0.108
	R3/8	0109 16 17	27	30	19	39	21	0.121
16	R1/2	0109 16 21	27	33.5	19	39	21	0.129
	R3/4	0109 16 27	27	36.5	23	41	23	0.185
	R1/2	0109 18 21	30	35.5	23	41	21.5	0.179
18	R3/4	0109 18 27	30	36.5	23	41	21.5	0.198
	R1/2	0109 20 21	32	36.5	23	42	21.5	0.183
	R3/4	0109 20 27	32	38	23	42	21.5	0.203
22	R3/4	0109 22 27	36	40	27	50	30	0.287
	R1	0109 22 34	36	44	27	50	30	0.336
25	R3/4	0109 25 27	41	43	27	54	30	0.328
	R1	0109 25 34	41	44	27	54	30	0.368
28	R3/4	0109 28 27	42	46	32	54	30	0.404
	R1	0109 28 34	42	48	32	54	30	0.382

Metric taper threads or NPT threads are available by special order, subject to minimum quantities.

0109 Stud Elbow, Male NPT Thread

Brass

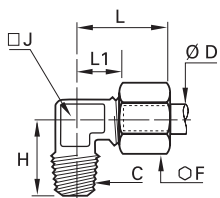

ØD	C		F	H	J	L _{max}	L1	Kg
6	NPT1/8	0109 06 11	13	18	8	22	11	0.021
	NPT1/4	0109 06 14	13	21.5	10	22	12	0.030
8	NPT1/8	0109 08 11	14	18.5	10	28	15	0.028
	NPT1/4	0109 08 14	14	22	10	28	15	0.033
10	NPT1/4	0109 10 14	19	25	12	30	14.5	0.053

0199 Stud Orientable Elbow, Male BSPP Thread

Brass, NBR

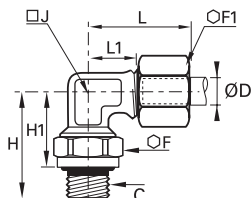

ØD	C		F	F1	H	H1	H1 _{max}	J	L _{max}	L1	Kg
4	G1/8	0199 04 10	14	10	23	16	17	8	19	9.5	0.022
	G1/4	0199 04 13	19	10	30.5	22	23.5	10	19	11	0.043
6	G1/8	0199 06 10	14	13	23	16	17	8	22	11	0.027
	G1/4	0199 06 13	19	13	30.5	22	23.5	10	22	12	0.046
8	G1/8	0199 08 10	14	14	24	17	18	10	28	15	0.034
	G1/4	0199 08 13	19	14	30.5	22	23.5	10	28	15	0.049
	G3/8	0199 08 17	22	14	33.5	24	25.5	12	28	15	0.065
10	G1/4	0199 10 13	19	19	31	22.5	24	12	30	14.5	0.067
	G3/8	0199 10 17	22	19	33.5	24	25.5	12	30	14.5	0.078
	G1/2	0199 10 21	27	19	40	29.5	31	19	37	22	0.137
14	G3/8	0199 14 17	22	24	35.5	26	27.5	19	35	18	0.118
	G1/2	0199 14 21	27	24	40	29.5	31	19	35	18	0.140
	G1/2	0199 18 21	27	30	40	29	30.5	23	41	21.5	0.187
18	G3/4	0199 18 27	32	30	43.5	32	33.5	23	41	21.5	0.222
	G3/4	0199 22 27	32	36	45.5	34	36	32	51	31	0.385
22	G1	0199 22 34	41	36	54	40.5	43	32	51	31	0.409
	G1	0199 28 34	41	42	54	40.5	43	32	54	30	0.411

The body will orientate for positioning purposes.

Brass Compression Fittings

0108 Stud Branch Tee, Male BSPT Thread

Brass

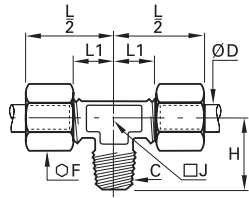

ØD	C		F	H	J	L1	L/2	Kg
4	R1/8	0108 04 10	10	17	8	9.5	19	0.025
5	R1/8	0108 05 10	12	17.5	8	11	21	0.031
6	R1/8	0108 06 10	13	18	8	11	22	0.033
	R1/4	0108 06 13	13	21.5	10	16	27	0.047
8	R1/8	0108 08 10	14	18.5	10	15	28	0.043
	R1/4	0108 08 13	14	22	10	15	28	0.050
10	R3/8	0108 08 17	14	24	12	15	28	0.061
	R1/4	0108 10 13	19	25	12	14.5	30	0.085
12	R3/8	0108 10 17	19	25.5	12	14.5	30	0.092
	R1/4	0108 12 13	22	26	15	15	30	0.114
14	R3/8	0108 12 17	22	27	15	15	30	0.117
	R3/8	0108 14 17	24	30	19	18	35	0.159
15	R1/2	0108 14 21	24	32	19	18	35	0.166
	R3/8	0108 15 17	24	30	19	18	35	0.147
16	R1/2	0108 15 21	24	32	19	18	35	0.155
	R3/8	0108 16 17	27	30	19	21	39	0.190
18	R1/2	0108 16 21	27	33.5	19	21	39	0.203
	R1/2	0108 18 21	30	35.5	23	21.5	41	0.270
20	R3/4	0108 18 27	30	36.5	23	21.5	41	0.292
	R3/4	0108 20 27	32	38	23	21.5	42	0.299
22	R3/4	0108 22 27	36	40	27	29	50	0.431
	R1	0108 22 34	36	44	27	29	50	0.466

Metric taper threads or NPT threads are available by special order, subject to minimum quantities.

0103 Stud Run Tee, Male BSPT Thread

Brass

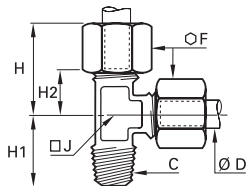

ØD	C		F	H _{max}	H1	H2	J	Kg
4	R1/8	0103 04 10	10	19	17	9.5	8	0.025
5	R1/8	0103 05 10	12	21	17.5	11	8	0.030
6	R1/8	0103 06 10	13	22	18	11	8	0.033
	R1/4	0103 06 13	13	27	21.5	16	10	0.046
8	R1/8	0103 08 10	14	28	18.5	15	10	0.044
	R1/4	0103 08 13	14	28	22	15	10	0.049
10	R3/8	0103 08 17	14	28	24	15	12	0.061
	R1/4	0103 10 13	19	30	25	14.5	12	0.084
12	R3/8	0103 10 17	19	30	25.5	14.5	12	0.091
	R1/4	0103 12 13	22	30	26	15	15	0.114
14	R3/8	0103 12 17	22	30	27	15	15	0.121
	R3/8	0103 14 17	24	35	30	18	19	0.161
15	R1/2	0103 14 21	24	35	32	18	19	0.171
	R3/8	0103 15 17	24	35	30	18	19	0.148
16	R1/2	0103 15 21	24	35	32	18	19	0.158
	R3/8	0103 16 17	27	39	30	21	19	0.188
18	R1/2	0103 16 21	27	39	33.5	21	19	0.202
	R1/2	0103 18 21	30	41	35.5	21.5	23	0.269
20	R3/4	0103 18 27	30	41	36.5	21.5	23	0.291
	R3/4	0103 20 27	32	42	38	21.5	23	0.298
22	R3/4	0103 22 27	36	50	40	29	27	0.435

Metric taper threads or NPT threads are available by special order, subject to minimum quantities.

Related Products

Parker also offers another type of brass compression fitting: **Metrulok**, with a one-piece olive/nut. Do not hesitate to contact us.



Brass Compression Fittings

0118 Single Banjo with Captive Sealing Washer, Male BSPP Thread

Brass, technical polymer

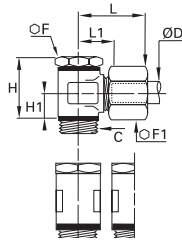

ØD	C		F	F1	H	H1	L _{max}	L1	N	Kg
4	G1/8	0118 04 10	14	10	24	9.5	24	14.5	17.5	0.038
	G1/8	0118 05 10	14	12	24	9.5	25	14.5	17.5	0.041
5	G1/4	0118 05 13	17	12	25	10	26	16	21	0.058
	G1/8	0118 06 10	14	13	24	9.5	25	14.5	17.5	0.041
6	G1/4	0118 06 13	17	13	25	10	26	16	21	0.056
	G1/8	0118 08 10	14	14	24	9.5	28	15.5	17.5	0.055
8	G1/4	0118 08 13	17	14	25	10	28	15.5	21	0.058
	G3/8	0118 08 17	22	14	32	13	30	18	26.5	0.110
10	G1/4	0118 10 13	17	19	31	13	34	19	23	0.117
	G3/8	0118 10 17	22	19	32	13	34	19	26.5	0.125
12	G1/4	0118 12 13	17	22	34	14.5	34	19	23	0.126
	G3/8	0118 12 17	22	22	35	14.5	34	19	26.5	0.138
14	G1/4	0118 14 13	17	24	37	16	37	20.5	28	0.154
	G3/8	0118 14 17	22	24	38	16	37	20.5	28	0.202
15	G1/2	0118 14 21	27	24	40	16	38	20.5	32.5	0.202
	G3/8	0118 15 17	22	24	38	16	37	20.5	28	0.189
16	G1/2	0118 15 21	27	24	40	16	38	20.5	32.5	0.196
	G1/2	0118 16 21	27	27	42	16	38	21	32.5	0.219
18	G1/2	0118 18 21	27	30	46	19.5	43	24.5	36	0.362
20	G3/4	0118 20 27	32	32	49	20	44	24.5	39	0.406
22	G3/4	0118 22 27	32	36	53	22	45	24.5	39	0.454

Thread with pre-assembled washer
Sealing washers 0602 can be found in chapter 9.

0118..39 Single Banjo with Bi-Material Seal, Male BSPP Thread

Brass, zinc-plated steel with NBR seal

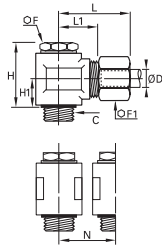

ØD	C		F	F1	H	H1	L _{max}	L1	N	Kg
4	G1/8	0118 04 10 39	14	10	23	9.5	24	14.5	17.5	0.039
	G1/8	0118 05 10 39	14	12	23	9.5	25	14.5	17.5	0.041
5	G1/4	0118 05 13 39	17	12	24	10	26	16	21	0.064
	G1/8	0118 06 10 39	14	13	23	9.5	25	14.5	17.5	0.042
6	G1/4	0118 06 13 39	17	13	24	10	26	16	21	0.057
	G1/8	0118 08 10 39	14	14	23	9.5	28	15.5	17.5	0.056
8	G1/4	0118 08 13 39	17	14	24	10	28	15.5	21	0.059
	G3/8	0118 08 17 39	22	14	31.5	13.5	30	18	26.5	0.113
10	G1/4	0118 10 13 39	17	19	30	13	34	19	23	0.119
	G3/8	0118 10 17 39	22	19	31.5	13.5	34	19	26.5	0.127
12	G1/4	0118 12 13 39	17	22	33	14.5	34	19	23	0.126
	G3/8	0118 12 17 39	22	22	34.5	15	34	19	26.5	0.136
14	G1/4	0118 14 13 39	17	24	36	16	37	20.5	28	0.190
	G3/8	0118 14 17 39	22	24	37.5	16.5	37	20.5	28	0.198
15	G1/2	0118 14 21 39	27	24	39	16.5	38	20.5	32.5	0.206
	G1/2	0118 15 21 39	27	24	40	16.5	38	20.5	32.5	0.202
16	G1/2	0118 16 21 39	27	27	40	16.5	38	21	32.5	0.222
	G1/2	0118 18 21 39	27	30	47	20	43	24.5	36	0.365
20	G3/4	0118 20 27 39	32	32	50	20.5	44	24.5	39	0.394
22	G3/4	0118 22 27 39	32	36	54	22.5	45	24.5	39	0.462

With bi-material sealing washer
The bi-material sealing washers, part number 0139, can be found in chapter 9.

Brass Compression Fittings

0119 Double Banjo with Captive Sealing Washer, Male BSPP Thread

Brass, technical polymer

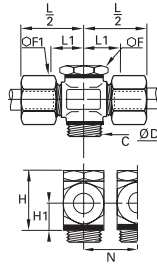

ØD	C		F	F1	H	H1	L1	L/2	N	Kg
4	G1/8	0119 04 10	14	10	24	9.5	14.5	24	17.5	0.051
	G1/8	0119 06 10	14	13	24	9.5	14.5	25	17.5	0.056
6	G1/4	0119 06 13	17	13	25	10	16	26.5	21	0.073
	G1/8	0119 08 10	14	14	24	9.5	15.5	28	17.5	0.070
8	G1/4	0119 08 13	17	14	25	10	15.5	28	21	0.075
	G3/8	0119 08 17	22	14	32	13	18	30.5	26.5	0.140
10	G1/4	0119 10 13	17	19	31	13	19	34	23	0.156
	G3/8	0119 10 17	22	19	32	13	19	34	26.5	0.173
12	G1/4	0119 12 13	17	22	34	14.5	19	34	23	0.173
	G3/8	0119 12 17	22	22	35	14.5	19	34	26.5	0.182
14	G1/4	0119 14 13	17	24	37	16	20.5	37.5	28	0.246
	G3/8	0119 14 17	22	24	38	16	20.5	37.5	28	0.245
	G1/2	0119 14 21	27	24	40	16	20.5	38	32.5	0.219

Thread with pre-assembled washer
Sealing washers 0602 can be found in Chapter 9.

0119..39 Double Banjo with Bi-Material Seal, Male BSPP Thread

Brass, zinc-plated steel with NBR seal

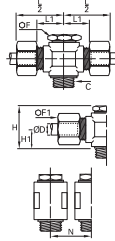

ØD	C		F	F1	H	H1	L1	L/2	N	Kg
4	G1/8	0119 04 10 39	14	10	23	9.5	14.5	24	17.5	0.050
	G1/8	0119 05 10 39	14	12	23	9.5	14.5	25	17.5	0.049
5	G1/4	0119 05 13 39	17	12	24	10	16	26	21	0.072
	G1/8	0119 06 10 39	14	13	23	9.5	14.5	25	17.5	0.057
6	G1/4	0119 06 13 39	17	13	24	10	16	26	21	0.071
	G1/8	0119 08 10 39	14	14	23	9.5	15.5	28	17.5	0.071
8	G1/4	0119 08 13 39	17	14	24	10	15.5	28	21	0.075
	G3/8	0119 08 17 39	22	14	31.5	13.5	18	30	26.5	0.137
10	G1/4	0119 10 13 39	17	19	30	13	19	34	23	0.156
	G3/8	0119 10 17 39	22	19	31.5	13.5	19	34	26.5	0.167
12	G1/4	0119 12 13 39	17	22	33	14.5	19	34	23	0.180
	G1/4	0119 14 13 39	17	24	36	16	20.5	37	28	0.248
14	G3/8	0119 14 17 39	22	24	37.5	16.5	20.5	37	28	0.247
	G1/2	0119 14 21 39	27	24	39	16.5	20.5	38	32.5	0.261
15	G3/8	0119 15 17 39	22	24	37.5	16.5	20.5	37	28	0.246
	G1/2	0119 15 21 39	27	24	40	16.5	20.5	38	32.5	0.251
18	G1/2	0119 18 21 39	27	30	47	20	24.5	43	36	0.471
20	G3/4	0119 20 27 39	32	32	50	20.5	24.5	44	39	0.638
22	G3/4	0119 22 27 39	32	36	54	22.5	24.5	45	39	0.610

Thread with pre-assembled washer
Bi-material sealing washers, part number 0139, can be found in Chapter 9.

0106 Equal Tube-to-Tube Connector

Brass

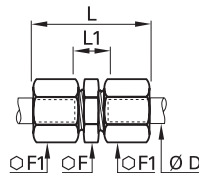

ØD		F	F1	L _{max}	L1	Kg
4	0106 04 00	10	10	28	10	0.017
5	0106 05 00	11	12	31	11	0.024
6	0106 06 00	11	13	32	11	0.026
8	0106 08 00	13	14	36	10	0.031
10	0106 10 00	17	19	42	13	0.070
12	0106 12 00	19	22	42	13	0.091
14	0106 14 00	22	24	45	11	0.103
15	0106 15 00	22	24	45	11	0.098
16	0106 16 00	24	27	48	13	0.142
18	0106 18 00	27	30	53	14	0.188
20	0106 20 00	30	32	56	14	0.215
22	0106 22 00	32	36	60	14	0.282
25	0106 25 00	36	41	64	14	0.401
28	0106 28 00	41	42	64	14	0.397

Brass Compression Fittings

0113 Equal Tube-to-Tube Connector with Mounting Boss

Brass

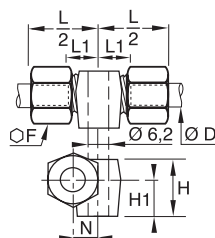

ØD		F	H	H1	L1	L/2	N	Kg
4	0113 04 00	10	10.5	7	9.5	19	6	0.021
6	0113 06 00	13	13	9	10	20.5	7	0.033
8	0113 08 00	14	14.5	9.5	11	23.5	8	0.040
10	0113 10 00	19	19.5	12.5	11	26	9	0.081
12	0113 12 00	22	22	14	12	26.5	11	0.108
14	0113 14 00	24	25	16	11	28	12	0.124

0116 Equal Bulkhead Connector

Brass

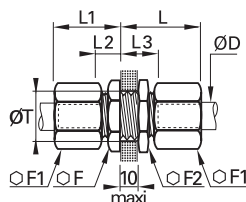

ØD		F	F1	F2	L max	L1 max	L2	L3	ØT min	Kg
4	0116 04 00	10	10	13	27	17	7	17	8.3	0.024
5	0116 05 00	13	12	14	28	18	7.5	17.5	10.3	0.035
6	0116 06 00	13	13	14	28	19	7.5	17.5	10.3	0.037
8	0116 08 00	14	14	17	29	20	7	17	12.3	0.045
10	0116 10 00	19	19	22	33	25	9	19	16.5	0.100
12	0116 12 00	22	22	22	33	25	9	19	18.5	0.121
14	0116 14 00	24	24	27	35	25	8	18	20.5	0.144
15	0116 15 00	24	24	24	35	25	8	18	20.5	0.134
16	0116 16 00	27	27	27	36	28	9.5	19.5	22.5	0.188
18	0116 18 00	27	30	30	40	30	10.5	20.5	24.5	0.238
20	0116 20 00	32	30	32	41	31	11	21	27.5	0.275
22	0116 22 00	36	36	36	42	32	11	21	30.5	0.376
25	0116 25 00	36	41	38	46	36	11	21	33.5	0.479

0102 Equal Elbow

Brass

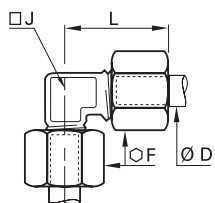

ØD		F	J	L max	Kg
4	0102 04 00	10	5	19	0.016
5	0102 05 00	12	8	21	0.025
6	0102 06 00	13	8	22	0.027
8	0102 08 00	14	10	28	0.038
10	0102 10 00	19	12	30	0.072
12	0102 12 00	22	15	30	0.098
14	0102 14 00	24	19	35	0.133
15	0102 15 00	24	19	35	0.123
16	0102 16 00	27	19	39	0.165
18	0102 18 00	30	23	41	0.230
20	0102 20 00	32	23	42	0.236
22	0102 22 00	36	27	50	0.373
25	0102 25 00	41	27	54	0.452
28	0102 28 00	42	32	54.5	0.474

Related Products

Parker also offers another type of brass compression fitting:

Metrulok, with a one-piece olive/nut.

Do not hesitate to contact us.



Brass Compression Fittings

0104 Equal Tee

Brass

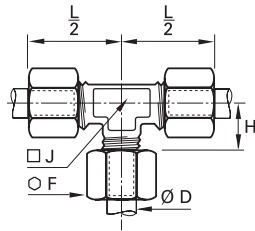

ØD		F	H	J	L/2	Kg
4	0104 04 00	10	9.5	8	19	0.028
5	0104 05 00	12	11	8	21	0.036
6	0104 06 00	13	11	8	22	0.040
8	0104 08 00	14	15	10	28	0.055
10	0104 10 00	19	14.5	12	30	0.105
12	0104 12 00	22	15	15	30	0.141
14	0104 14 00	24	18	19	35	0.186
15	0104 15 00	24	18	19	35	0.174
16	0104 16 00	27	21	19	39	0.234
18	0104 18 00	30	21.5	23	41	0.319
20	0104 20 00	32	21.5	23	42	0.330
22	0104 22 00	36	29	27	50	0.516
25	0104 25 00	41	29	27	54	0.637
28	0104 28 00	42	30	32	55	0.661

0142 Equal Y Piece with Mounting Boss

Brass

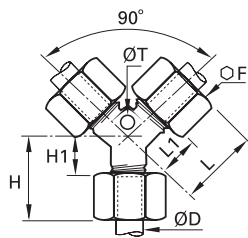

ØD		F	H max	H1	L max	L1	ØT	Kg
4	0142 04 00	10	16.5	7	26.5	17	4.2	0.032
6	0142 06 00	13	19.5	8.5	28	17	4.2	0.049
8	0142 08 00	14	21	8	30	17	6.2	0.061
10	0142 10 00	19	24.5	9	37.5	22	6.2	0.128
12	0142 12 00	22	26	11	38	23	6.2	0.110
14	0142 14 00	24	28	11	41.5	24.5	6.2	0.201
15	0142 15 00	24	28	11	41.5	24.5	6.2	0.204
16	0142 16 00	27	30	12	43	25	6.2	0.252
18	0142 18 00	30	31.5	12	50.5	31	10.2	0.353

0107 Equal Cross

Brass

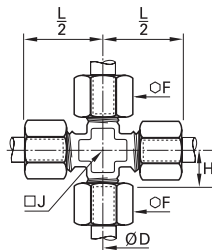

ØD		F	H	J	L/2	Kg
4	0107 04 00	10	9.5	8	19	0.035
5	0107 05 00	12	11	8	21	0.047
6	0107 06 00	13	11	8	22	0.052
8	0107 08 00	14	15	11	28	0.074
10	0107 10 00	19	14.5	14	30	0.142
12	0107 12 00	22	15	15	35	0.234
14	0107 14 00	24	18	20	35	0.246
15	0107 15 00	24	18	20	35	0.224
16	0107 16 00	27	21	20	39	0.309
18	0107 18 00	30	21.5	25	41	0.423
20	0107 20 00	32	21.5	25	42	0.429
22	0107 22 00	36	29	27	50	0.670
25	0107 25 00	41	29	27	50	0.833

Complementary Brass Fittings

Reducers, Olives and Nuts

This innovative reducer system, using a full range of nuts and olives, enables **different diameters** of steel, copper, brass or polymer tubes to be fitted onto **a single Parker Legris compression fitting**.

Product Advantages

Efficient Solution

Reduces envelope dimensions
Quick and easy to assemble, whatever the diameters and tube material
Improved stock management
Silicone-free

Multiple Combinations

A single connector for up to 4 different tube materials and sizes
Example:

- polymer tube 4 mm O.D.
- copper tube 8 mm O.D.
- brass tube 12 mm O.D.
- braided PVC hose 12 mm I.D.

 A full range of olives and nuts to optimise all assembly operations



Pneumatics
Cooling
Automotive Process
Lubrication
Fluid Transmission
Packaging
Industrial Machinery

Applications

Regulations

DI: 97/23/EC (PED)
RG: 1907/2006 (REACH)
DI: 2002/95/EC (RoHS)
DI: 94/9/EC (ATEX)

Reducer Assembly Procedure

Operation	Assembly Sequence	Assembled Fitting
<p>1 Assemble the reducer Place the reducer in the fitting body.</p>	<p>1</p>	
<p>2 Assemble the nut and olive Place the nut and then the olive onto the tube.</p>	<p>2</p>	
<p>3 Assemble the nut Push the tubing into the fitting until it butts against the tube reducer. Tighten the nut to the recommended torque (see opposite page).</p>	<p>3</p>	

Complementary Brass Fittings

Assembly Configuration

The table and information given below illustrate the large number of options available with Parker Legris brass compression fittings. To these must be added the advantages specific to the original Parker Legris reducer shown on the previous page.



0110 Brass			0110..60 Brass		0110..40 Steel	0110..70* Polymer
0124 Brass			0124 Brass	0111 BNA** Brass	0124...40 Steel	
No olive required to assemble the plug						No olive required to assemble the tube
Brass plug: 0126	Copper, cold-rolled brass, polymer tube and barb connectors 0122 and 0165	Coiled annealed copper tube	Cold-rolled copper tube for vibration and side loading, etc.	Coiled annealed copper tube for vibration and side loading, etc.	Steel or copper tube: low/medium hydraulic pressure, lubricate before assembly	Polymer tube

*Assembly specifications for nut-olive 0110..70

This part functions as both olive and nut for flexible polymer tube assemblies:

1. Hand tighten the polymer nut-olive a few turns onto the body of the fitting; the knurling makes this easier.
2. Then introduce the polymer tube and push home into the body of the fitting.
3. Continue manually tightening the polymer nut-olive.
4. Finish tightening using a spanner until the nut body disengages and turns freely, which acts as a torque limiter.

N.B.: To avoid damaging the threads, do not insert the tube before hand tightening the nut-olive into the body of the fitting.

**Bureau de Normalisation de l'Automobile (French Automotive Bureau of Standards)

Recommended Tightening Torque

Tightening torque

in daN.m =

maximum tightening torque of a **0110** nut and **0124** olive with copper, brass or steel tube.

Nut **0110** and **0110..40**

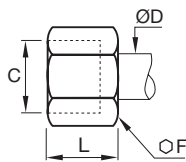

Nut **0110..60**

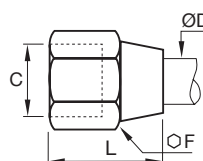

Ø D (mm)	ØF 0110	ØF 0110..60	max. daN.m copper or brass	ØF 0110..40	max. daN.m steel
4	10	11	0.7	10	1.5
5	12	13	0.7	12	1.5
6	13	13	1.5	13	2.5
8	14	16	1.5	14	2.5
10	19	20	1.8	19	3
12	22	22	3	22	4.5
14	24	24	3.5	24	5.5
15	24	24	4	24	6
16	27	27	5	27	7
18	30	30	6	30	9
20	32	32	6	32	10
22	36	36	7	36	12
25	41	41	8	41	13
28	42		9		

Complementary Brass Compression Fittings

0166

3-Piece Reducer

Brass

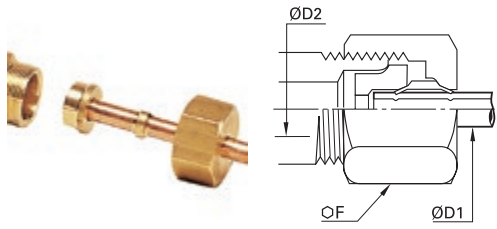

ØD1	ØD2		F	Kg
4	5	0166 04 05	13	0.011
	6	0166 04 06	13	0.011
	8	0166 04 08	14	0.012
	10	0166 04 10	19	0.030
	12	0166 04 12	22	0.044
5	14	0166 04 14	24	0.054
	15	0166 04 15	24	0.056
	6	0166 05 06	13	0.011
	8	0166 05 08	14	0.012
	10	0166 05 10	19	0.030
6	12	0166 05 12	22	0.044
	14	0166 05 14	24	0.053
	16	0166 05 16	27	0.078
	8	0166 06 08	14	0.011
	10	0166 06 10	19	0.030
8	12	0166 06 12	22	0.043
	14	0166 06 14	24	0.052
	15	0166 06 15	24	0.054
	16	0166 06 16	27	0.077
	10	0166 08 10	19	0.027
10	12	0166 08 12	22	0.040
	14	0166 08 14	24	0.050
	15	0166 08 15	24	0.052
	16	0166 08 16	27	0.077
	18	0166 08 18	30	0.099
12	12	0166 10 12	22	0.037
	14	0166 10 14	24	0.045
	15	0166 10 15	24	0.047
	16	0166 10 16	27	0.068
	18	0166 10 18	30	0.095
14	20	0166 10 20	32	0.107
	22	0166 10 22	36	0.146
	25	0166 10 25	41	0.209
	14	0166 12 14	24	0.042
	15	0166 12 15	24	0.044
16	16	0166 12 16	27	0.066
	18	0166 12 18	30	0.091
	20	0166 12 20	32	0.102
	22	0166 12 22	36	0.141
	25	0166 12 25	41	0.200
18	16	0166 14 16	27	0.060
	18	0166 14 18	30	0.085
	20	0166 14 20	32	0.095
	22	0166 14 22	36	0.134
	25	0166 14 25	41	0.189
20	18	0166 15 18	30	0.081
	22	0166 15 22	36	0.130
	18	0166 16 18	30	0.078
22	20	0166 16 20	32	0.087
	22	0166 16 22	36	0.125
	25	0166 16 25	41	0.185
25	20	0166 18 20	32	0.082
	22	0166 18 22	36	0.118
	25	0166 18 25	41	0.180
	28	0166 18 28	42	0.177
30	20	0166 20 25	41	0.168
	22	0166 22 28	42	0.168

ØD1: tube to be fitted

ØD2: for a x mm fitting

Each of the above part numbers comprises:

- a reduction piece
- an olive, PN 0124
- a sleeve nut

Complementary Brass Compression Fittings

0124 Brass Olive

Brass

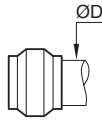

ØD		Kg
4	0124 04 00	0.001
5	0124 05 00	0.001
6	0124 06 00	0.001
8	0124 08 00	0.001
10	0124 10 00	0.003
12	0124 12 00	0.004
14	0124 14 00	0.005
15	0124 15 00	0.004
16	0124 16 00	0.006
18	0124 18 00	0.007
20	0124 20 00	0.009
22	0124 22 00	0.012
25	0124 25 00	0.017
28	0124 28 00	0.017

0124..40 Steel Olive

Zinc-plated steel

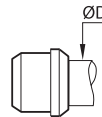

ØD		Kg
4	0124 04 00 40	0.001
6	0124 06 00 40	0.001
8	0124 08 00 40	0.001
10	0124 10 00 40	0.003
12	0124 12 00 40	0.003
14	0124 14 00 40	0.005
15	0124 15 00 40	0.004
16	0124 16 00 40	0.006
18	0124 18 00 40	0.007
20	0124 20 00 40	0.008
22	0124 22 00 40	0.010
25	0124 25 00 40	0.014

0111 BNA* Brass Olive

Brass

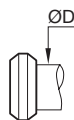

ØD		Kg
4	0111 04 00	0.001
5	0111 05 00	0.001
6	0111 06 00	0.001
8	0111 08 00	0.001
10	0111 10 00	0.002
12	0111 12 00	0.002
14	0111 14 00	0.002
15	0111 15 00	0.003
16	0111 16 00	0.003

*Bureau de Normalisation de l'Automobile

Related Products

Parker also offers another type of brass compression fitting: **Metrulok**, with a one-piece olive/nut.

Do not hesitate to contact us.



Complementary Brass Compression Fittings

0110 Brass Nut

Brass

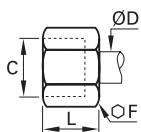

ØD	C		F	L	Kg
4	M8x1	0110 04 00	10	11	0.005
5	M10x1	0110 05 00	12	11	0.006
6	M10x1	0110 06 00	13	11	0.008
8	M12x1	0110 08 00	14	13	0.009
10	M16x1.5	0110 10 00	19	15	0.018
12	M18x1.5	0110 12 00	22	15	0.026
14	M20x1.5	0110 14 00	24	15	0.029
15	M20x1.5	0110 15 00	24	15	0.029
16	M22x1.5	0110 16 00	27	17	0.042
18	M24x1.5	0110 18 00	30	18	0.055
20	M27x1.5	0110 20 00	32	18	0.057
22	M30x1.5	0110 22 00	36	19	0.080
25	M33x1.5	0110 25 00	41	21	0.121
28	M36x1.5	0110 28 00	42	21	0.108

0110..40 Steel Nut

Zinc-plated steel

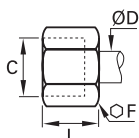

ØD	C		F	L	Kg
4	M8x1	0110 04 00 40	10	11	0.004
5	M10x1	0110 05 00 40	12	11.5	0.006
6	M10x1	0110 06 00 40	13	12	0.008
8	M12x1	0110 08 00 40	14	13.5	0.008
10	M16x1.5	0110 10 00 40	19	16	0.018
12	M18x1.5	0110 12 00 40	22	16.5	0.026
14	M20x1.5	0110 14 00 40	24	17	0.030
15	M20x1.5	0110 15 00 40	24	17	0.030
16	M22x1.5	0110 16 00 40	27	18	0.043
18	M24x1.5	0110 18 00 40	30	19	0.057
20	M27x1.5	0110 20 00 40	32	20.5	0.061
22	M30x1.5	0110 22 00 40	36	21.5	0.085

0110..60 Brass Long Nut

Brass

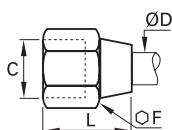

ØD	C		F	L	Kg
4	M8x1	0110 04 00 60	11	14.5	0.007
5	M10x1	0110 05 00 60	13	17	0.008
6	M10x1	0110 06 00 60	13	17.5	0.011
8	M12x1	0110 08 00 60	16	20	0.019
10	M16x1.5	0110 10 00 60	20	23	0.032
12	M18x1.5	0110 12 00 60	22	25	0.039
14	M20x1.5	0110 14 00 60	24	30	0.051
15	M20x1.5	0110 15 00 60	24	30	0.049
18	M24x1.5	0110 18 00 60	30	35	0.098
20	M27x1.5	0110 20 00 60	32	35	0.102
22	M30x1.5	0110 22 00 60	36	36	0.129

0110..70 Technical Polymer Nut-Olive

Technical polymer

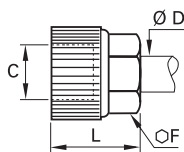

ØD	C		F	L	Kg
4	M8x1	0110 04 00 70	8	13	0.008
6	M10x1	0110 06 00 70	11	15	0.002
8	M12x1	0110 08 00 70	13	16	0.002
10	M16x1.5	0110 10 00 70	17	19	0.004
12	M18x1.5	0110 12 00 70	19	19	0.005
14	M20x1.5	0110 14 00 70	22	20	0.005

NB: polymer nut-olives should not be used on metal tubes.



Brass Compression Fittings

Compression Fittings

Self-Fastening Barb Connectors for NBR Hose

This range of fittings is designed to meet the requirements of the automotive and robotics industries, combining as it does **optimum CNOMO manufacturing quality**, simple installation, reliable operation and a **long service life**.

Product Advantages

Perfect for Self-Fastening NBR Hose

- Quick and simple to install
- Compatible with the Parker Legris range of brass compression fittings
- Mechanical properties proven for use in industrial robotic installations
- Spark-resistant

Ergonomic and Time-Saving

- Fitting does not require lubrication or clamping, reducing assembly time
- Visual stop confirms installation is correct and improves operating safety
- Removal by cutting the tube
- The fitting can be re-used if necessary



Applications

- Welding Robots
- Pneumatics
- Compressed Air Systems
- Automotive Process
- Cooling

Technical Characteristics

Compatible Fluids	Coolants, compressed air
Working Pressure	0 to 16 bar
Working Temperature	0°C to +100°C (water) -20°C to +70°C (air)

Tightening Torque, Type 0132	DN	6	8	10	14	18	22
	daN.m	0.7	1.5	1.8	3.5	6	7

Reliable performance is dependent upon the type of fluid conveyed and hose being used.

Component Materials

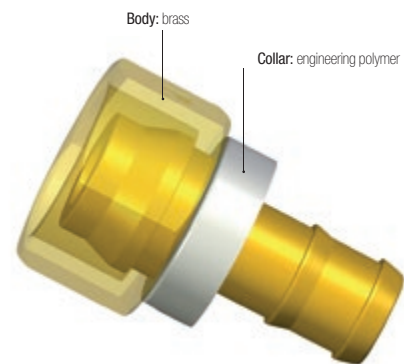

Silicone-free

Self-Fastening Hose Assembly Machine

Machine designed to assemble a barb connector and a self-fastening NBR hose.

Machine part number: **0650 00 00 05**



Tube Cutting and Positioning

Cut the hose square and position the barb connector on the mounting tool.

Barb Connector Support

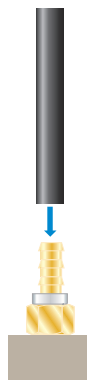

Press-Fitting the Tube

Activate the press-fit tool; connection is complete when the tube is fully home on the barb connector. This tool has been designed for use with 5 different diameters and is easy to operate.

Barb Connector Support

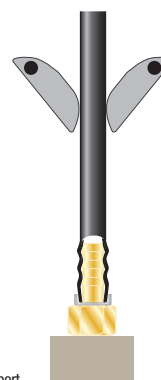

Regulations

Industrial

DI: 2002/95/EC (RoHS), 2011/65/EC

DI: 97/23/EC (PED)

RG: 1907/2006 (REACH)

CNOMO: E07.21.115N

Self-Fastening Barb Connectors for NBR Hose

0132 Self-Fastening Barb Connector for Brass Compression Fitting

Brass

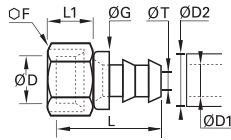

ØD	ØD1	ØD2		F	G	L	L1	ØT	Kg
6	6.3	13	0132 06 56	12	16.5	32.5	12.5	4.8	0.010
8	6.3	13	0132 08 56	14	16.5	29.5	11.5	4.8	0.015
10	6.3	13	0132 10 56	19	16.5	30	14	4.8	0.028
	9.5	16	0132 10 60	19	19.5	34	14	7.5	0.030
14	9.5	16	0132 14 60	24	19.5	35.5	15	7.5	0.050
	12.7	19	0132 14 62	24	23.5	39.5	15	10	0.054
18	12.7	19	0132 18 62	30	23.5	41.5	17	10	0.090
	15.9	23	0132 18 66	30	27	50	17	13.5	0.090
22	19.1	27	0132 22 69	36	30.5	56.5	17	16	0.128

Polymer collar

0133..39 Self-Fastening Bar Connector with Bi-Material Seal, Male BSPP Thread

Brass, zinc-plated steel with NBR seal

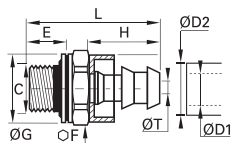

ØD1	ØD2	C		E	F	G	H	L	ØT	Kg
6.3	13	G1/8	0133 56 10 39	5.5	13	14	20	31.5	4.8	0.012
		G1/4	0133 56 13 39	7	17	17	20	33.5	4.8	0.018
9.5	16	G1/4	0133 60 13 39	7	17	17	24	37.5	7.5	0.021
		G3/8	0133 60 17 39	9.5	22	22	24	42.5	7.5	0.038
12.7	19	G3/8	0133 62 17 39	9.5	22	22	28	46.5	10	0.044
		G1/2	0133 62 21 39	10.5	27	26	28	48.5	10	0.060
15.9	23	G1/2	0133 66 21 39	10.5	27	26	36.5	57	13.5	0.063
		G3/4	0133 66 27 39	11.5	32	32	36.5	59	13.5	0.096
19.1	27	G3/4	0133 69 27 39	11.5	32	32	43	65.5	16	0.111

Thread with bi-material seal and polymer collar
Bi-material sealing washers part number 0139 can be found in chapter 9.

0134 Self-Fastening Barb Connector, Male BSPT Thread

Brass

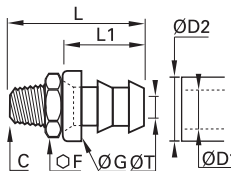

ØD1	ØD2	C		F	G	L	L1	ØT	Kg
6.3	13	R1/8	0134 56 10	14	16.5	32.5	20	4.8	0.015
		R1/4	0134 56 13	14	16.5	37	20	4.8	0.020
9.5	16	R1/4	0134 60 13	14	19.5	41	24	7.5	0.022
		R3/8	0134 60 17	19	19.5	41.5	24	7.5	0.036
12.7	19	R3/8	0134 62 17	19	23.5	45.5	28	10	0.038
		R1/2	0134 62 21	22	23.5	50	28	10	0.062
15.9	23	R1/2	0134 66 21	22	27	58.5	36.5	13.5	0.056
		R3/4	0134 66 27	27	27	60.5	36.5	13.5	0.101
19.1	27	R3/4	0134 69 27	27	30.5	67	43	16	0.108

Polymer collar

Self-fastening NBR hose is selected by nominal diameter; for example:

Barb Connector	O.D. (Tube)	Ø DN (Tube)	Self-Fastening NBR hose
0132 10 56	10	1/4	10..H 56...



Brass Adaptors

0122 Barb Connector for Hose

Brass

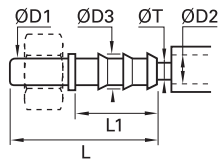

ØD1	ØD2		ØD3	L	L1	ØT min	Kg
4	4	0122 04 04	6	37.5	22.5	3	0.004
5	4	0122 05 04	6	37.5	22.5	3	0.003
6	4	0122 06 04	6	37.5	22.5	3	0.005
	7	0122 06 07	9	37.5	22.5	6	0.007
8	6	0122 08 06	8	40	22.5	5	0.007
	7	0122 08 07	9	40	22.5	6	0.008
	10	0122 08 10	12.5	40	22.5	9	0.012
10	7	0122 10 07	9	43	22.5	6	0.010
	10	0122 10 10	12.5	43	22.5	9	0.014
12	10	0122 12 10	12.5	43	22.5	9	0.013
	13	0122 12 13	15	50	29.5	12	0.018
14	13	0122 14 13	15	52	29.5	12	0.019
	16	0122 14 16	18.5	60.5	38	15	0.031
15	13	0122 15 13	15	52	29.5	12	0.020
	16	0122 15 16	18.5	60.5	38	15	0.032
16	13	0122 16 13	15	53.5	29.5	12	0.021
	16	0122 16 16	18.5	62	38	15	0.032
18	16	0122 18 16	18.5	62	38	15	0.032
	19	0122 18 19	21.5	62	38	18	0.040
20	16	0122 20 16	18.5	64	38	15	0.034
	19	0122 20 19	21.5	64	38	18	0.039
22	19	0122 22 19	21.5	64	38	18	0.041
25	19	0122 25 19	21.5	70	38	18	0.048
	25	0122 25 25	27.5	70	38	24	0.054
28	25	0122 28 25	27.5	70	38	24	0.087

0165 Barb Connector for Flexible Tubing

Brass

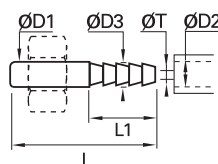

ØD1	ØD2		ØD3	L	L1	ØT min	Kg
4	4	0165 04 06	4.3	30	15	2	0.002
5	4	0165 05 06	4.3	30	15	2	0.003
6	4	0165 06 06	4.3	30	15	2	0.003
	6	0165 06 08	6.4	30	15	4	0.004
8	8	0165 06 10	8.4	30	15	4	0.004
	6	0165 08 08	6.4	32.5	15	4	0.005
8	8	0165 08 10	8.4	32.5	15	6	0.006
	10	0165 08 12	10.7	37.5	20	8	0.009
	8	0165 10 10	8.4	35.5	15	6	0.008
10	10	0165 10 12	10.7	40.5	20	8	0.010
	12	0165 10 14	12.7	40.5	20	8	0.012
12	10	0165 12 12	10.7	40.5	20	8	0.011
	12	0165 12 14	12.7	40.5	20	10	0.012
14	12	0165 14 14	12.7	42.5	20	10	0.015
15	13	0165 15 16	13.7	42.5	20	11	0.015
16	13	0165 16 16	13.7	44	20	11	0.018

Assembly: Barb Connectors

Our barb connectors 0122 and 0165 are designed to be used with different types of hose. They are secured using the nut and olive provided with the fitting.

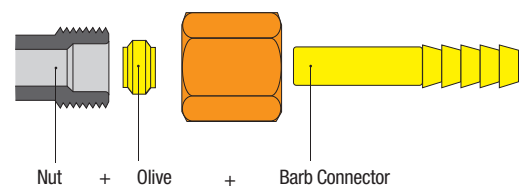

Brass Adaptors

0126 Plug for Compression Fitting

Brass

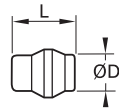

ØD		L	Kg
4	0126 04 00	10	0.002
5	0126 05 00	10	0.003
6	0126 06 00	10	0.003
8	0126 08 00	11.5	0.006
10	0126 10 00	13	0.010
12	0126 12 00	13	0.014
14	0126 14 00	13.5	0.020
15	0126 15 00	13.5	0.022
16	0126 16 00	16	0.030
18	0126 18 00	16	0.038
20	0126 20 00	16	0.045
22	0126 22 00	18	0.003
28	0126 28 00	19.5	0.108

The plug is used to blank off an outlet in a compression fitting, replacing the olive.

When an open outlet is required, simply dismantle and replace the plug with the tube olive, reusing the nut. The plug is also reusable.

0125 Tube End Plug for Compression Fitting

Brass

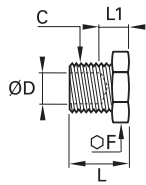

ØD	C		F	L	L1	Kg
4	M8x1	0125 04 00	10	12	8	0.006
6	M10x1	0125 06 00	11	13.5	9.5	0.008
8	M12x1	0125 08 00	14	14	9	0.012
10	M16x1.5	0125 10 00	17	18	11	0.025
12	M18x1.5	0125 12 00	19	18	11	0.030
14	M20x1.5	0125 14 00	22	19	11	0.041

This plug enables unused tubes to be blanked off.

The male thread on the plug has the same pitch as the female thread on the sleeve nut of a standard Parker Legris fitting.

Therefore the plug screwed into the sleeve nut blanks off the tube.

To reopen the passage, simply unscrew the plug and fit the required coupler.

No further treatment of the tube is required.

0220 Hex Head Plug, Male BSPP and Metric Thread

Brass, technical polymer

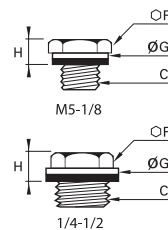

C		F	G	H1	Kg
M5x0.8	0220 19 00	8	8	5	0.002
G1/8	0220 10 00	14	14	7.5	0.011
G1/4	0220 13 00	17	17	7.5	0.020
G3/8	0220 17 00	17	22	8.5	0.024
G1/2	0220 21 00	22	27	10	0.041

Thread with pre-assembled sealing washer

M5: with screwdriver slot for tightening

Maximum allowable working pressure = 20 bar

Part number with suffix 99, maximum allowable working pressure = 250 bar, example: 0220 19 00 99

Conforms to BNA 229 (with the exception of M5 model), BSPP thread, ISO ISO 228-1,

Parallel metric thread, ISO NFE 03-054

0220..39 Hex Head Plug with Bi-Material Seal, Male BSPP Thread

Brass, zinc-plated steel with NBR seal

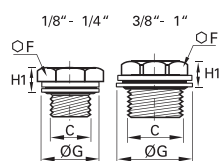

C		F	G	H	Kg
G1/8	0220 10 00 39	14	14	6.5	0.012
G1/4	0220 13 00 39	17	17	6.5	0.020
G3/8	0220 17 00 39	17	22	8	0.025
G1/2	0220 21 00 39	22	26	9	0.043
G3/4	0220 27 00 39	22	32	10	0.060
G1	0220 34 00 39	27	39.5	10.5	0.089

Plug with bi-material seal

Bi-material washers part number 0139 can be found in chapter 9.

Brass Adaptors

0120

Stud Standpipe, Male BSPT Thread

Brass

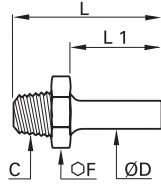

ØD	C		F	L	L1	Kg
4	R1/8	0120 04 10	11	25.5	14	0.007
5	R1/8	0120 05 10	11	26	14.5	0.007
6	R1/8	0120 06 10	11	26.5	15	0.008
	R1/4	0120 06 13	14	31	15	0.015
8	R1/8	0120 08 10	11	28.5	17	0.009
	R1/4	0120 08 13	14	33	17	0.016
	R3/8	0120 08 17	17	33.5	17	0.020
10	R1/4	0120 10 13	14	36	20	0.018
	R3/8	0120 10 17	17	36.5	20	0.022
12	R1/2	0120 12 21	22	41	20	0.040
	R1/4	0120 12 13	14	36	20	0.018
14	R3/8	0120 12 17	17	36.5	20	0.022
	R1/2	0120 12 21	22	41	20	0.040
15	R3/8	0120 14 17	17	38	21.5	0.023
	R1/2	0120 14 21	22	42.5	21.5	0.041
16	R3/8	0120 15 17	17	38	21.5	0.023
	R1/2	0120 15 21	22	42.5	21.5	0.041
18	R3/8	0120 16 17	17	39.5	23	0.024
	R1/2	0120 16 21	22	44	23	0.042
20	R1/2	0120 18 21	22	44.5	23.5	0.042
	R3/4	0120 18 27	27	47.5	23.5	0.071
22	R3/4	0120 20 27	27	49	25	0.070
	R3/4	0120 22 27	27	48.5	25.5	0.067
25	R1	0120 22 34	36	52.5	25.5	0.117
28	R1	0120 25 34	36	57	30	0.118
		0120 28 34	36	57	30	0.140

0112

Sleeve Nut for Compression Fitting, Male Metric Thread

Brass

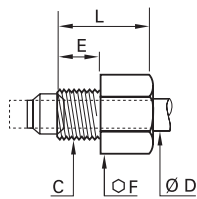

ØD	C		E	F	L	Kg
4	M8x1	0112 04 00	7	10	13	0.005
5	M10x1	0112 05 00	7.5	11	13.5	0.007
6	M10x1	0112 06 00	7.5	11	13.5	0.006
8	M12x1	0112 08 00	8	13	15	0.009
10	M16x1.5	0112 10 00	11	17	18	0.018
12	M18x1.5	0112 12 00	11	19	18	0.021
14	M20x1.5	0112 14 00	11	22	18	0.026

This product was designed to allow the tube to be fitted directly into the tapped port in a body using a standard Parker Legris olive.

For the corresponding drawings (cavity for Parker Legris olive), please consult us.

Brass Adaptors

0128..39 Stud Standpipe with Bi-Material Seal, Male BSPP Thread

Brass, zinc-plated steel with NBR seal

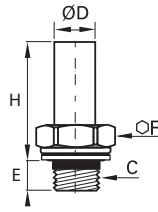

ØD	C		E	F	H	Kg
4	G1/8	0128 04 10 39	7.5	13	20	0.009
	G1/4	0128 04 13 39	9	17	22	0.015
6	G1/8	0128 06 10 39	7.5	13	21	0.010
	G1/4	0128 06 13 39	9	17	23	0.016
8	G1/8	0128 08 10 39	7.5	13	23	0.011
	G1/4	0128 08 13 39	9	17	25	0.017
	G3/8	0128 08 17 39	12	22	26	0.032
10	G1/4	0128 10 13 39	9	17	28	0.018
	G3/8	0128 10 17 39	12	22	29	0.034
14	G1/2	0128 10 21 39	27	27	30	0.049
	G3/8	0128 14 17 39	12	22	30.5	0.035
18	G1/2	0128 14 21 39	27	27	31.5	0.049
	G3/4	0128 18 21 39	27	27	33.5	0.051
22	G3/4	0128 18 27 39	14	32	34.5	0.084
	G1	0128 22 27 39	14	32	36.5	0.082
28	G1	0128 22 34 39	16.5	41	38	0.123
	G1	0128 28 34 39	16.5	41	42.5	0.147

With bi-material seal. Bi-material washers part number 0139 can be found in Chapter 9.

0151..39 Straight Male Orientable Adaptor, with Bi-Material Seal, Male BSPP Thread

Brass, NBR, zinc-plated steel with NBR seal

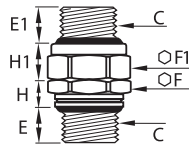

C		E	E1	F	F1	H	H1	Kg
G1/8	0151 10 10 39	5.5	7	13	14	6	6.5	0.017
G1/4	0151 13 13 39	7	8.5	17	19	6.5	9	0.036
G3/8	0151 17 17 39	9.5	9.5	22	22	9	9	0.056
G1/2	0151 21 21 39	10.5	10.5	27	27	10	10	0.083
G3/4	0151 27 27 39	11.5	11.5	32	32	11	10	0.121
G1	0151 34 34 39	13	13.5	41	41	12.5	10.5	0.217

With bi-material seal.

Bi-material washers part number 0139 can be found in Chapter 9.

0168..39 Reducer, with Bi-Material Seal, Male BSPP Thread/Female BSPP and Metric Thread

Brass, zinc-plated steel with NBR seal

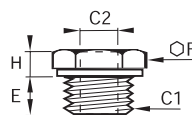

C1	C2		E	F	H	Kg
G1/8	M5x0.8	0168 10 19 39	8	14	4.5	0.009
	M5x0.8	0168 13 19 39	8	17	5	0.018
G1/4	G1/8	0168 13 10 39	8	17	5	0.012
	G1/8	0168 17 10 39	10	19	5	0.020
G3/8	G1/4	0168 17 13 39	10	19	5	0.013
	G1/8	0168 21 10 39	12	24	7.5	0.052
G1/2	G1/4	0168 21 13 39	12	24	7.5	0.044
	G3/8	0168 21 17 39	12	24	7.5	0.031
G3/4	G1/4	0168 27 13 39	12	32	9.5	0.100
	G3/8	0168 27 17 39	12	32	9.5	0.086
	G1/2	0168 27 21 39	12	32	9.5	0.065

With bi-material seal.

Bi-material washers part number 0139 can be found in Chapter 9.

Brass Adaptors

0127

Brass Tube Support for Polymer Tubing

Brass

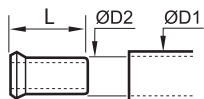

ØD1	ØD2		L	Kg
4	2	0127 04 00	11	0.001
	2.7	0127 04 27	11	0.001
5	3	0127 05 03	11	0.001
	3.3	0127 05 00	11.5	0.009
6	4	0127 06 00	11.5	0.001
	5.5	0127 08 55	14	0.001
8	6	0127 08 00	14	0.001
	7	0127 10 07	18	0.001
10	7.5	0127 10 75	18	0.001
	8	0127 10 00	18	0.002
12	8	0127 12 08	18	0.002
	9	0127 12 09	18	0.002
14	10	0127 12 00	18	0.001
	11	0127 14 11	18	0.002
15	12	0127 14 00	18	0.002
	12	0127 15 12	18	0.002
16	13	0127 16 13	18	0.003
18	14	0127 18 14	19.5	0.003
20	15	0127 20 15	20.5	0.003
22	16	0127 22 16	21	0.004
25	19	0127 25 19	25	0.007

This tube support guarantees good gripping, at high temperatures and pressures, by preventing collapsing of the tube.

Stainless Steel Compression Fitting Range

Stainless Steel Fittings

Stud Fittings

1805
BSPT
Page 5-34

1805
NPT
Page 5-34

1814
BSPP
Page 5-34

1809
BSPT
Page 5-35

1809
NPT
Page 5-35

1820
BSPT
Page 5-35

1820
NPT
Page 5-35



Tube-to-Tube Fittings

1806
Page 5-36

1816
Page 5-36

1802
Page 5-36

1804
Page 5-36



Complementary Fittings

1866
Page 5-39

1824
Page 5-39

1810
Page 5-39



Accessories

1822
Page 5-39

1827
Page 5-39



Stainless Steel
Compression Fittings

Compression Fittings

Stainless Steel Compression Fittings

Manufactured in 316L stainless steel, these fittings combine all the advantages of the "universal" compression fitting with **excellent resistance** to environmental conditions and **corrosive fluids**. They are pressure and temperature-resistant and are able to withstand strong vibration and water hammer.

Product Advantages

For Use in Many Environments

Manufactured in 316L stainless steel
 Suitable for all environments and fluids
 Resistant to water hammer and vibration
 Excellent sealing and retention of the tube
 Suitable for pneumatic and medium pressure hydraulic applications
 Metallic sealing guarantees maximum service life

Many Tube Options

Possibility of easily connecting different tube materials and diameters to the same fitting body
 No tube support required for rigid and semi-rigid polyamide tubing below 12 mm



Food Process
 Fluid Transmission
 Pneumatics
 Automotive Process
 Petrochemical
 Chemical
 Offshore Oil & Gas

Applications

Technical Characteristics

Compatible Fluids	Many fluids					
Working Pressure	Vacuum to 400 bar (80 bar in corrosive environments)					
Working Temperature	-60°C to +250°C with metal tubing					

Tightening Torques	DN	6	8	10	12	16
	daN.m	2	3	4	6.5	9.5

Reliable performance is dependent upon the type of fluid conveyed and tubing being used. Guaranteed for use with a vacuum of 755 mm Hg (99% vacuum). Thread sealing must be guaranteed by user.

Component Materials

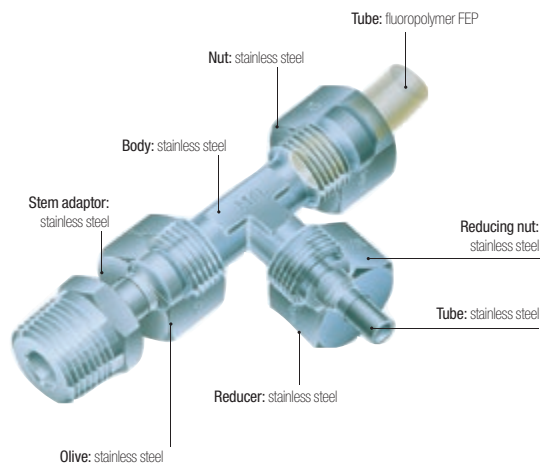

Silicone-free

Maximum Bore Diameters

The table below shows the recommended compatibility of tube size, BSPP male thread and maximum bore.

Tube O.D	BSPP Thread	Max. Bore
6	G1/8	4
6-8-10	G1/4	7
10-12	G3/8	11
16	G1/2	14

Tube Length for Assembly

Minimum length of tube (L) between 2 fittings.

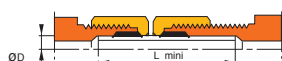

ØD	L mm	ØD	L mm
4	26.5	10	39
6	26	12	39
8	32	16	46.5

Regulations

DI: 2002/95/EC (RoHS), 2011/65/EC
 DI: 97/23/EC (PED)
 RG: 1935/2004
 RG: 1907/2006 (REACH)
 DI: 94/09/EC (ATEX)
 FDA: 21 CFR 177.1550
 NACE MR0175: compatible materials
 ISO 15156-1/-2/-3: compatible materials

Stainless Steel Compression Fittings

Installation

Fitting

The fitting comprises three parts (body/olive/nut). For assembly procedure, please see Brass Compression Fitting page.

Diagram: Assembled Fitting

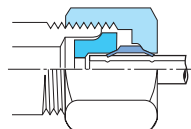

A very slight distortion of the tube appears; this shows the fitting has been correctly tightened.

Orientable Elbow Assembly

Elbow
1802

Adaptor
1820

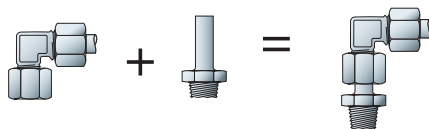

Customised Fittings

If our standard range does not meet your needs, Parker Legris can develop customised solutions for your applications.

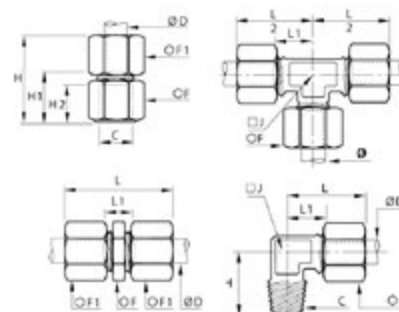

Technical Characteristics

The use of Parker Legris stainless steel compression fittings is dependant on the tube material. Tables of recommended working pressure for the different tubes are shown below.

Recommended Tube Type

Semi-rigid polyamide or fluoropolymer tube

Stainless steel tube

"Thin Wall" cold-drawn seamless, annealed and passivated: wall thickness tolerance ± 0.1 mm. For use with "thin wall" stainless steel tube from 6 mm to 16 mm O.D., maximum wall thickness 1 mm.

Recommended Tube/Fitting Assembly Configurations

Assembled using Parker Legris olive and nut in stainless steel, with a tube support.

Stainless steel tube

Stainless steel tube: in cold-rolled straight lengths
Coiled annealed stainless tube: reduces working pressure by 35%; do not use if there is vibration.

Semi-Rigid Polyamide Tube

Maximum Working Pressure (bar)

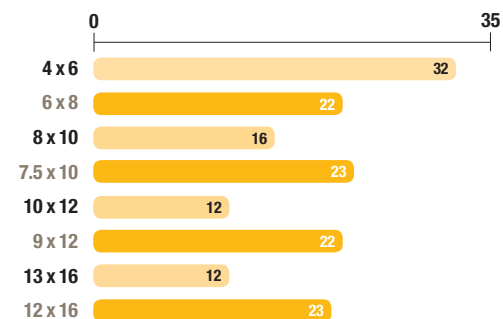

Stainless Steel Tube

Maximum Working Pressure (bar)

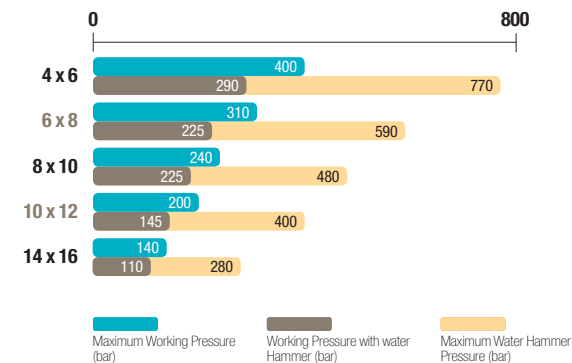

Working Pressure Coefficients for Semi-Rigid Tubing

Temperature °C	-40°C / -15°C	-15°C / +30°C	+30°C / +50°C	+50°C / +70°C	+70°C / +100°C
Factor	1.8	1	0.68	0.55	0.31

The above recommendations are given in good faith. However, since each application is different, it is advisable to undertake tests in actual working conditions.

Stainless Steel Compression Fittings

1805 Stud Fitting, Male BSPT Thread

Stainless steel 316L

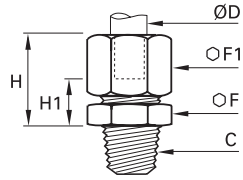

ØD	C		F	F1	H _{max}	H1	Kg
6	R1/8	1805 06 10	12	13	19.5	7.5	0.017
	R1/4	1805 06 13	14	13	19.5	7.5	0.024
8	R1/8	1805 08 10	13	14	21	7	0.019
	R1/4	1805 08 13	14	14	21	7	0.025
10	R1/4	1805 10 13	17	19	25.5	9	0.043
	R3/8	1805 10 17	17	19	25.5	9	0.049
	R1/2	1805 10 21	22	19	26.5	10	0.077
12	R1/4	1805 12 13	19	22	26	9	0.054
	R3/8	1805 12 17	19	22	26	9	0.057
	R1/2	1805 12 21	22	22	27	10	0.081
16	R3/8	1805 16 17	24	27	28.5	9.5	0.085
	R1/2	1805 16 21	24	27	28.5	9.5	0.095

1805 Stud Fitting, Male NPT Thread

Stainless steel 316L

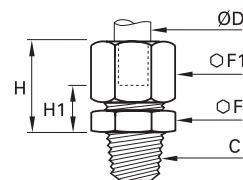

ØD	C		F	F1	H _{max}	H1	Kg
6	NPT1/8	1805 06 11	12	13	19.5	7.5	0.018
	NPT1/4	1805 06 14	14	13	19.5	7.5	0.027
	NPT3/8	1805 06 18	19	13	20.5	8.5	0.033
8	NPT1/2	1805 06 22	22	13	21.5	9.5	0.049
	NPT1/8	1805 08 11	13	14	21	7	0.020
	NPT1/4	1805 08 14	14	14	21	7	0.027
10	NPT1/4	1805 10 14	17	19	25.5	9	0.046
	NPT3/8	1805 10 18	19	19	25.5	9	0.055
	NPT1/2	1805 10 22	22	19	26.5	10	0.081
12	NPT1/4	1805 12 14	19	22	26	9	0.056
	NPT3/8	1805 12 18	19	22	26	9	0.060
	NPT1/2	1805 12 22	22	22	27	10	0.087
16	NPT3/8	1805 16 18	24	27	28.5	9.5	0.087
	NPT1/2	1805 16 22	24	27	28.5	9.5	0.097

1814 Stud Fitting, Female BSPP Thread

Stainless steel 316L

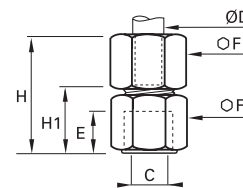

ØD	C		E	F	F1	H _{max}	H1	Kg
6	G1/8	1814 06 10	7.5	14	13	29	17	0.023
	G1/4	1814 06 13	11	17	13	29	21	0.032
8	G1/4	1814 08 13	11	17	14	34.5	20.5	0.033
	G3/8	1814 10 17	11.5	22	19	38.5	22	0.064
10	G1/2	1814 10 21	15	27	19	43	26.5	0.094
	G3/8	1814 12 17	11.5	22	22	39	22	0.073
12	G1/2	1814 12 21	15	27	22	43.5	26.5	0.103
	G1/2	1814 16 21	15	27	27	45	26	0.121

Stainless Steel Compression Fittings

1809 Stud Elbow, Male BSPT Thread

Stainless steel 316L

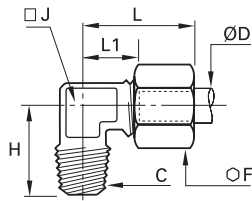

ØD	C		F	H	J	L _{max}	L1	Kg
6	R1/8	1809 06 10	13	18	8	25.5	13.5	0.020
	R1/4	1809 06 13	13	23	10	25.5	13.5	0.029
8	R1/8	1809 08 10	14	20.5	10	28.5	14.5	0.026
	R1/4	1809 08 13	14	23	10	28.5	14.5	0.030
10	R1/4	1809 10 13	19	25	12	32.5	16	0.050
	R3/8	1809 10 17	19	25.5	12	32.5	16	0.058
12	R1/2	1809 10 21	19	32	18	36.5	20	0.093
	R1/4	1809 12 13	22	26	14	34	17	0.067
16	R3/8	1809 12 17	22	27	14	34	17	0.069
	R1/2	1809 12 21	22	32	18	37	20	0.100
16	R3/8	1809 16 17	27	28.5	18	39.5	21	0.108
	R1/2	1809 16 21	27	31.5	18	39.5	21	0.115

1809 Stud Elbow, Male NPT Thread

Stainless steel 316L

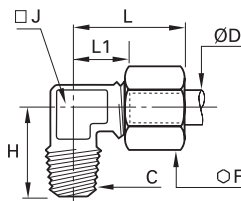

ØD	C		F	H	J	L _{max}	L1	Kg
6	NPT1/8	1809 06 11	13	19.5	8	25.5	13.5	0.021
	NPT1/4	1809 06 14	13	25.5	10	25.5	13.5	0.032
	NPT3/8	1809 06 18	13	28	12	27	15	0.046
	NPT1/2	1809 06 22	13	34	12	29	17	0.071
8	NPT1/8	1809 08 11	14	22	10	28.5	14.5	0.027
	NPT1/4	1809 08 14	14	25.5	10	28.5	14.5	0.033
10	NPT1/4	1809 10 14	19	27.5	12	32.5	16	0.052
	NPT3/8	1809 10 18	19	28	12	32.5	16	0.062
	NPT1/2	1809 10 22	19	35	18	36.5	20	0.096
12	NPT1/4	1809 12 14	22	28.5	14	34	17	0.068
	NPT3/8	1809 12 18	22	29.5	14	34	17	0.073
	NPT1/2	1809 12 22	22	35	18	37	20	0.104
16	NPT3/8	1809 16 18	27	31	18	39.5	21	0.110
	NPT1/2	1809 16 22	27	34.5	18	39.5	21	0.116

1820 Stud Standpipe, Male BSPT Thread

Stainless steel 316L

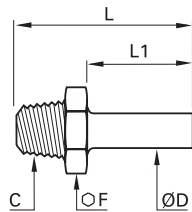

ØD	C		F	L	L1	Kg
6	R1/8	1820 06 10	12	26.5	15	0.009
	R1/4	1820 06 13	14	31	15	0.018
8	R1/8	1820 08 10	12	28.5	17	0.008
	R1/4	1820 08 13	14	33	17	0.017
10	R1/4	1820 10 13	14	36	20	0.017
	R3/8	1820 10 17	17	36.5	20	0.025
	R1/2	1820 10 21	22	41	20	0.053
12	R1/4	1820 12 13	14	36	20	0.016
	R3/8	1820 12 17	17	36.5	20	0.022
16	R1/2	1820 12 21	22	41	20	0.049
	R3/8	1820 16 17	17	39.5	23	0.022
16	R1/2	1820 16 21	22	44	23	0.039

1820 Stud Standpipe, Male NPT Thread

Stainless steel 316L

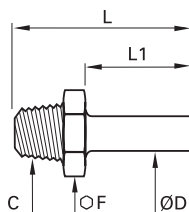

ØD	C		F	L	L1	Kg
6	NPT1/8	1820 06 11	12	26.5	15	0.010
	NPT1/4	1820 06 14	14	31	15	0.019
8	NPT1/8	1820 08 11	12	28.5	17	0.009
	NPT1/4	1820 08 14	14	33	17	0.019
10	NPT1/4	1820 10 14	14	36	20	0.018
	NPT3/8	1820 10 18	19	36.5	20	0.032
	NPT1/2	1820 10 22	22	41	20	0.060
12	NPT1/4	1820 12 14	14	36	20	0.019
	NPT3/8	1820 12 18	19	36.5	20	0.028
	NPT1/2	1820 12 22	22	41	20	0.053
16	NPT3/8	1820 16 18	19	39.5	23	0.027
	NPT1/2	1820 16 22	22	44	23	0.042

Stainless Steel Compression Fittings

1806 Equal Tube-to-Tube Connector

Stainless steel 316L

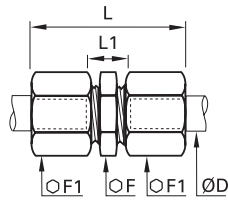

ØD		F	F1	L _{max}	L1	Kg
6	1806 06 00	12	13	34.5	11	0.024
8	1806 08 00	13	14	38.5	10	0.029
10	1806 10 00	17	19	46	13	0.066
12	1806 12 00	19	22	47	13	0.085
16	1806 16 00	24	27	51	13	0.136

1816 Equal Bulkhead Connector

Stainless steel 316L

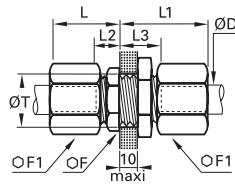

ØD		F	F1	L _{max}	L1 _{max}	L2	L3	ØT _{min}	Kg
6	1816 06 00	13	13	28	19	7.5	17	10.5	0.035
8	1816 08 00	14	14	29	20	7	17	12.5	0.042
10	1816 10 00	19	19	33	25	9	19	16.5	0.093
12	1816 12 00	22	22	33	25	9	19	18.5	0.113
16	1816 16 00	27	27	36	28	9.5	19.5	22.5	0.179

1802 Equal Elbow

Stainless steel 316L

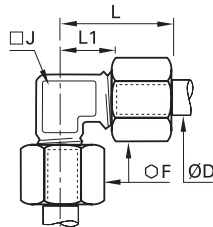

ØD		F	J	L _{max}	L1	Kg
6	1802 06 00	13	8	25.5	13.5	0.027
8	1802 08 00	14	10	28.5	14.5	0.035
10	1802 10 00	19	12	32.5	16	0.069
12	1802 12 00	22	14	34	17	0.093
16	1802 16 00	27	18	39.5	21	0.152

1804 Equal Tee

Stainless steel 316L

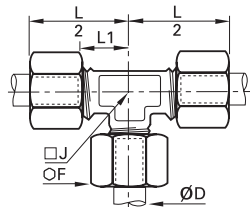

ØD		F	J	L1	L/2	Kg
6	1804 06 00	13	8	13.5	25.5	0.039
8	1804 08 00	14	10	14.5	28.5	0.049
10	1804 10 00	19	12	16	32.5	0.102
12	1804 12 00	22	14	17	34	0.132
16	1804 16 00	27	18	21	39.5	0.215



Stainless Steel
Compression Fittings

Compression Fittings

Complementary Stainless Steel Fittings

Reducers, Olives and Nuts

This innovative reducer system, using a full range of nuts and olives, enables **different diameters** of stainless steel, fluoropolymer or polymer tubes to be fitted onto **a single Parker Legris compression fitting**.

Product Advantages

Efficient Solution

- Reduces envelope dimensions
- Quick and easy to assemble, whatever the diameters and tube material
- Improved stock management
- Silicone-free

Multiple Combinations

- A single connector for up to 3 different tube materials and sizes.
- Example:
- Advanced PE tubing 6 mm O.D.
 - stainless steel tubing 8 mm O.D.
 - fluoropolymer tubing 12 mm O.D. or braided PVC hose 10 mm I.D.
- A full range of olives and nuts to optimise all assembly operations



Applications

- Food Process
- Fluid Transmission
- Pneumatics
- Automotive Process
- Petrochemical
- Cooling & Heating
- Chemical
- Offshore Oil & Gas

Reducer Assembly Procedure

Operation	Assembly Sequence	Assembled Fitting
<p>1</p> <p>Assemble the reducer Place the reducer in the fitting body.</p>	<p>1</p>	
<p>2</p> <p>Assemble the nut and olive Place the nut and then the olive onto the tube.</p>	<p>2</p>	
<p>3</p> <p>Assemble the nut Push the tube into the fitting until it bottoms on the reducer. Tighten the nut to the recommended torque (see opposite page).</p>	<p>3</p>	

Assembly: Barb Connectors

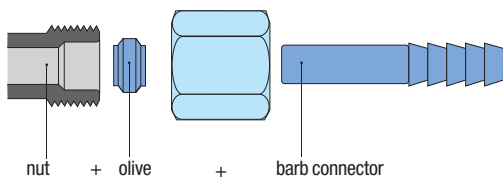

Regulations

DI: 2002/95/EC (RoHS), 2011/65/EC
 DI: 97/23/EC (PED)
 RG: 1935/2004
 RG: 1907/2006 (REACH)
 DI: 94/09/EC (ATEX)
 FDA: 21 CFR 177.1550
 NACE MR0175: compatible materials
 ISO 15156-1/-2/-3: compatible materials

Our barb connector 1822 is designed to be also used with different types of hose. It is secured using the nut and olive provided with the fitting.

Stainless Steel Compression Fittings

1866 3-Piece Reducer

Stainless steel 316L

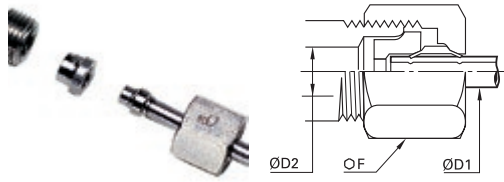

ØD1	ØD2		F	Kg
6	8	1866 06 08	14	0.011
	10	1866 06 10	19	0.027
	12	1866 06 12	22	0.040
8	10	1866 08 10	19	0.025
	12	1866 08 12	22	0.037
10	12	1866 10 12	22	0.034
	16	1866 10 16	27	0.065
12	16	1866 12 16	27	0.061

1824 Stainless Steel Olive

Stainless steel 316L



ØD		Kg
6	1824 06 00	0.001
8	1824 08 00	0.001
10	1824 10 00	0.003
12	1824 12 00	0.004
16	1824 16 00	0.005

1810 Stainless Steel Nut

Stainless steel 316L

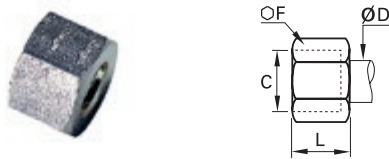

ØD	C		F	L	Kg
6	M10x1	1810 06 00	13	11	0.007
8	M12x1	1810 08 00	14	13	0.008
10	M16x1.5	1810 10 00	19	15	0.017
12	M18x1.5	1810 12 00	22	15	0.024
16	M22x1.5	1810 16 00	27	17	0.041

1822 Barb Adaptor for Hose

Stainless steel 316L

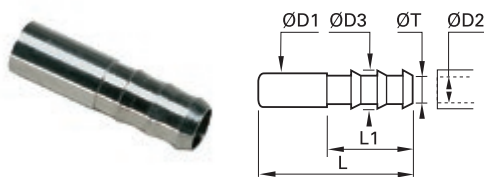

ØD1	ØD2		ØD3	L	L1	ØT min	Kg
6	7	1822 06 07	9	37.5	22.5	6	0.006
	6	1822 08 06	8	40	22.5	5	0.007
8	7	1822 08 07	9	40	22.5	6	0.007
	10	1822 08 10	12.5	40	22.5	9	0.011
10	7	1822 10 07	9	43	22.5	6	0.009
	10	1822 10 10	12.5	43	22.5	9	0.013
12	10	1822 12 10	12.2	43	22.5	9	0.012
	13	1822 12 13	15	50	29.5	13	0.016

1827 Stainless Steel Tube Support for Fluoropolymer Tubing

Stainless steel 316L

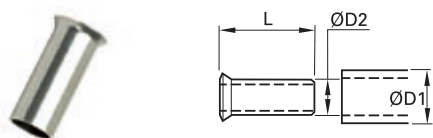

ØD1	ØD2		L	Kg
6	4	1827 06 00	11.5	0.001
8	6	1827 08 00	14	0.001
10	8	1827 10 00	18	0.001
12	9	1827 12 09	18	0.001
	10	1827 12 00	18	0.001
16	14	1827 16 00	18	0.002

This tube support is necessary when using fluoropolymer tubing at all temperatures compatible with the fitting/tubing assembly.

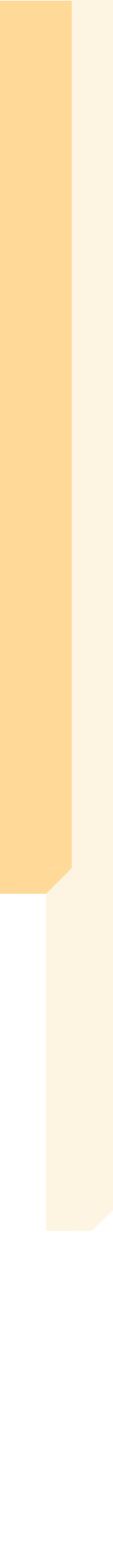

PL Nickel-Plated Brass Spigot Fitting Range

Stud Fittings

Straights

- F3BPL**
BSPT
Page 5-43
- F3BPL-1**
BSPT
Page 5-43
- F4BPL**
BSPP
Page 5-43
- F8BPL**
Metric
Page 5-43
- F8BPL-1**
Metric
Page 5-43



Elbows

- C3BPL**
BSPT
Page 5-44
- C3BPL-1**
BSPT
Page 5-44
- C4BPL**
BSPP
Page 5-44
- C8BPL**
Metric
Page 5-44



Tees

- R3BPL**
BSPT
Page 5-45
- S3BPL**
BSPT
Page 5-45



Banjo Fitting

Banjo Fitting

- COR4BPL**
BSPP
Page 5-45



Tube-to-Tube Fittings

Straights

- HBPL**
Union
Page 5-46
- HBPL-1**
Union
Page 5-46



Tees

- JBPL**
Union
Page 5-46
- JBPL-1**
Union
Page 5-46



Bulkhead Connectors

- WBPL**
Page 5-47
- WBPL-1**
Page 5-47



Complementary Fittings

- BPLM**
Nut
Page 5-47
- BPLM-M**
Nut
Page 5-47
- 0164**
NPT/BSPP
Page 5-47



PL Nickel-Plated Brass Spigot Fittings

This range of Parker Legris has a sealing system which guarantees **excellent sealing and full flow**. PL fittings for flexible tubing are **fully re-usable**. They provide excellent compatibility with a wide variety of fluids.

Product Advantages

Rapid Assembly

Nut design allows for easy tightening
 Quick to assemble and disassemble
 Compatible with flexible and semi-rigid tubes (polyurethane, polyamide, polyethylene, fluoropolymers, etc.)
 Mechanical stop on the body to prevent overtightening

Performance

Reliable direct sealing system without the use of a seal or olive
 Low pressure
 Nickel-plated for increased corrosion resistance



Food Process
 Painting
 Pneumatic Systems
 Chemical
 Welding
 Laboratories
 Railway

Applications

Technical Characteristics

Compatible Fluids	Compressed air Other fluids: contact us
Working Pressure	Vacuum to 18 bar with BPLM-M nut Vacuum to 40 bar with BPLM nut
Working Temperature	-40°C to +100°C

Tightening Torque (Nm)	M5x0.8	M6x1	1/8	1/4	3/8	1/2
BSPT Thread			8	12	14	16
BSPP Thread with "O" ring			1.2	1.5	2.5	3.5
BSPP Thread with metal sleeve			5	8	10	12
Metric Thread	0.8	0.8				

Reliable performance is dependent upon the type of fluid conveyed, component materials and tubing being used.
 Guaranteed for use with a vacuum of 755 mm Hg (99% vacuum).
 For use with fire-proof tubing: please consult us.

Component Materials

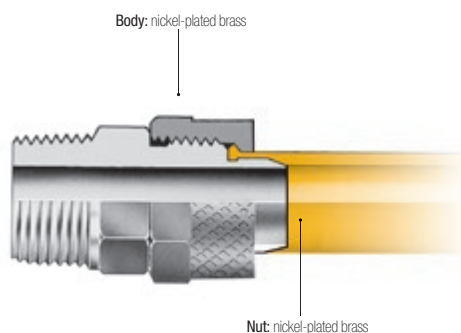

Silicone-free

Installation

Cutting the Tube



Cut the polymer tube square.

Preparing the Connection



Slide the nut onto the tube.

Connecting the Tube



Push the tube home into the body of the fitting.

Final Assembly





Tighten the nut by hand (in the case of soft tubing) or using a spanner (for semi-rigid tubing) until it comes into contact with the end stop.

Stud Fittings

F3BPL Stud Fitting, Male BSPT Thread

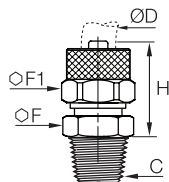
Nickel-plated brass





ØD	C		F	F1	H	Kg	
2.7x4	R1/8		F3BPL2.7/4-1/8	12	8	24	0.009
4x6	R1/8		F3BPL4/6-1/8	12	12	27.5	0.016
	R1/4		F3BPL4/6-1/4	14	12	31	0.025
6x8	R1/8		F3BPL6/8-1/8	12	14	27.5	0.019
	R3/8		F3BPL6/8-3/8	14	14	31	0.026
8x10	R1/4		F3BPL8/10-1/4	14	16	32.5	0.031
	R3/8		F3BPL8/10-3/8	17	16	33	0.043
10x12	R3/8		F3BPL10/12-3/8	17	18	34.5	0.036

Compatible with BPLM-M nut only

F3BPL-1 Stud Fitting, Male BSPT Thread

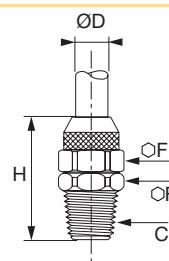
Nickel-plated brass





ØD	C		F	F1	H	Kg	
7.5x10	R1/4		F3BPL7.5/10-1/4	14	16	27.5	0.031
	R3/8		F3BPL7.5/10-3/8	17	16	28.5	0.037
11x14	R3/8		F3BPL11/14-3/8	19	22	32.5	0.058

Compatible with BPLM nut only
Maximum working pressure: 40 bar

F4BPL Stud Fitting, Male BSPP Thread

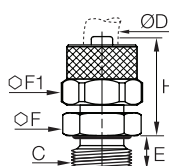
Nickel-plated brass, NBR



ØD	C		E	F	F1	H	Kg	
4x6	G1/8		F4BPL4/6-1/8	6	13	12	25.5	0.031
6x8	G1/4		F4BPL6/8-1/4	8	16	14	28	0.033

Compatible with BPLM-M nut only

F8BPL Stud Fitting, Male Metric Thread

Nickel-plated brass, NBR

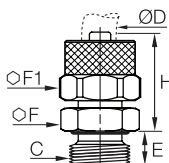

ØD	C		E	F	F1	H	Kg	
6x8	M10x1		F8BPL6/8M10	7	14	13	28	0.025

Compatible with BPLM-M nut only

F8BPL-1 Stud Fitting, Male Metric Thread

Nickel-plated brass, copper

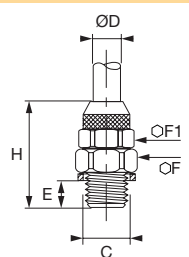

ØD	C		E	F	F1	H	Kg	
6x8	M12x1.25		F8BPL6/8M12	8	17	14	28	0.028

Compatible with BPLM nut only
Maximum working pressure: 40 bar
These fittings are supplied with a copper seal.

Stud Fittings

C3BPL Stud Elbow, Male BSPT Thread

Nickel-plated brass

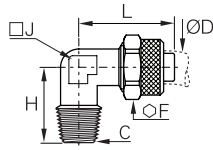

ØD	C		F	H	J	L	Kg
2.7x4	R1/8	C3BPL2.7/4-1/8	8	17	8	19.5	0.018
	R1/8	C3BPL4/6-1/8	12	17	8	22.5	0.022
4x6	R1/4	C3BPL4/6-1/4	12	20	10	22.5	0.031
	R1/8	C3BPL6/8-1/8	14	17	10	22.5	0.029
6x8	R1/4	C3BPL6/8-1/4	14	20	10	22.5	0.031
	R3/8	C3BPL6/8-3/8	14	22.5	11	24	0.064
8x10	R1/4	C3BPL8/10-1/4	16	21.5	11	25.5	0.057
	R3/8	C3BPL8/10-3/8	16	22.5	11	25.5	0.057
10x12	R3/8	C3BPL10/12-3/8	18	24.5	14	30	0.060

Compatible with BPLM-M nut only

C3BPL-1 Stud Elbow, Male BSPT Thread

Nickel-plated brass

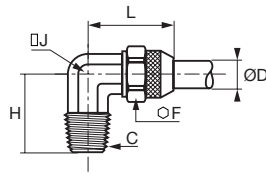

ØD	C		F	H	J	L	Kg
7.5x10	R1/4	C3BPL7.5/10-1/4	16	22.5	12	28	0.057
	R3/8	C3BPL7.5/10-3/8	16	23	12	28	0.058
11x14	R3/8	C3BPL11/14-3/8	22	25	16	34	0.094

Compatible with BPLM nut only

Maximum working pressure: 40 bar

C4BPL Stud Elbow, Male BSPP Thread

Nickel-plated brass, NBR

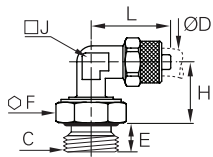

ØD	C		E	F	F1	H	J	L	Kg
6x8	G1/4	C4BPL6/8-1/4	8	17	14	25	10	23.5	0.068

These fittings are supplied with nitrile seals.

Compatible with BPLM-M nut only

C8BPL-1 Stud Elbow, Male Metric Thread

Nickel-plated brass, NBR

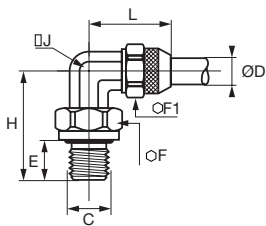

ØD	C		E	F	F1	H	J	L	Kg
6x8	M10x1	C8BPL6/8M10	7	14	13	27	10	22	0.034
	M12x1	C8BPL6/8M12	7	13	13	26	12	25	0.074

These fittings are supplied with nitrile seals.

Compatible with BPLM nut only

Maximum working pressure: 40 bar

Stud Fittings

R3BPL Stud Run Tee, Male BSPT Thread

Nickel-plated brass

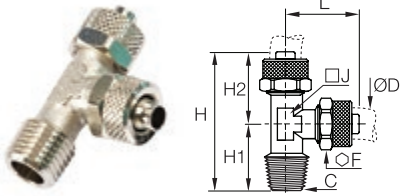

	ØD	C		F	H	H1	H2	J	Kg
4x6	R1/8	R3BPL4/6-1/8		12	39.5	17	22.5	8	0.035
	R1/4	R3BPL4/6-1/4		12	43.5	21	22.5	10	0.048
6x8	R1/8	R3BPL6/8-1/8		14	40.5	18	22.5	10	0.045

Compatible with BPLM-M nut only

S3BPL Stud Branch Tee, Male BSPT Thread

Nickel-plated brass

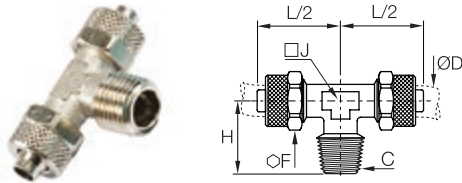

	ØD	C		F	H	J	L2	Kg
4x6	R1/8	S3BPL4/6-1/8		12	17	8	22.5	0.035
	R1/4	S3BPL4/6-1/4		12	20.5	10	22.5	0.047
6x8	R1/8	S3BPL6/8-1/8		14	17.5	10	22.5	0.046

Compatible with BPLM-M nut only

COR4BPL Single Banjo, Male BSPP Thread

Nickel-plated brass, treated steel, NBR

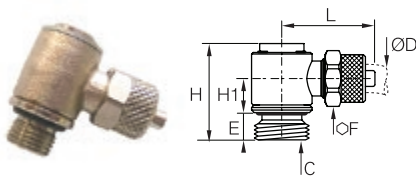

	ØD	C		E	F	H	H1	L	Kg
4x6	G1/8	COR4BPL4/6-1/8		6.5	12	25.5	9	24	0.069
	G1/4	COR4BPL4/6-1/4		8	12	31.5	10	26	0.097
6x8	G1/8	COR4BPL6/8-1/8		6.5	14	25.5	9	24	0.073

These parts are supplied with peripheral seals.

The banjo bolt is made of steel.

Compatible with BPLM-M nut only

PL Tube-to-Tube and Complementary Fittings

HBPL Equal Tube-to-Tube Connector

Nickel-plated brass

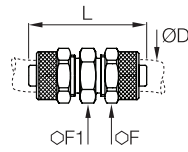

ØD		F	F1	L	Kg
2.7x4	HBPL2.7/4	8	8	26	0.010
4x6	HBPL4/6	12	12	34.5	0.021
6x8	HBPL6/8	14	14	35	0.030
8x10	HBPL8/10	14	16	38	0.043
10x12	HBPL10/12	17	18	41	0.056

Compatible with BPLM-M nut only

HBPL-1 Equal Tube-to-Tube Connector

Nickel-plated brass

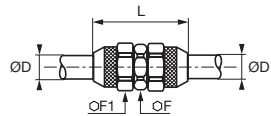

ØD		F	F1	L	Kg
11x14	HBPL11/14	19	22	40	0,087

Compatible with BPLM nut only
Maximum working pressure: 40 bar

JBPL Equal Tee

Nickel-plated brass

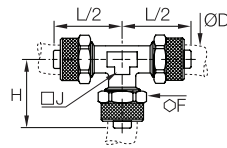

ØD		F	H	J	L2	Kg
2.7x4	JBPL2.7/4	8	20	8	22	0.035
4x6	JBPL4/6	12	22.5	8	22.5	0.042
6x8	JBPL6/8	14	22.5	10	22.5	0.057
8x10	JBPL8/10	16	25.5	11	25.5	0.085
10x12	JBPL10/12	18	30	14	30	0.100

Compatible with BPLM-M nut only

JBPL-1 Equal Tee

Nickel-plated brass

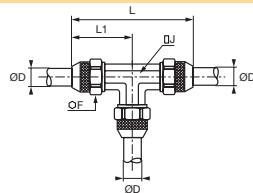

ØD		F	J	L	L1	Kg
7.5x10	JBPL7.5/10	16	12	56	28	0.086
11x14	JBPL11/14	22	16	68	34	0.168

Compatible with BPLM nut only
Maximum working pressure: 40 bar

PL Tube-to-Tube and Complementary Fittings

WBPL

Equal Bulkhead Connector

Nickel-plated brass

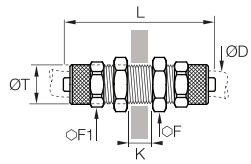

ØD		F	F1	K _{max}	L	ØT	Kg
4x6	WBPL4/6	14	12	10.5	48	10	0.030
6x8	WBPL6/8	16	14	10.5	48	12	0.040
8x10	WBPL8/10	17	16	8.5	50	14	0.057
10x12	WBPL10/12	19	18	8.5	53	26	0.064

Compatible with BPLM-M nut only

WBPL-1

Equal Bulkhead Connector

Nickel-plated brass

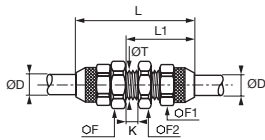

ØD		F	F1	F2	K _{max}	L	L1	ØT	Kg
11x14	WBPL11/14	22	22	22	5	50	28	19	0.114

Compatible with BPLM nut only
Maximum working pressure: 40 bar.

BPLM

Nut

Nickel-plated brass

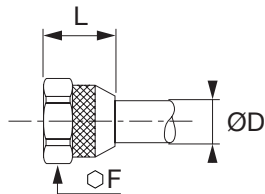

ØD	C		F	L	Kg
6x8	M11x0.75	BPL8M	13	13	0.008
7.5x10	M13x1	BPL10M	16	14	0.014
11x14	M18x1.5	BPL14M	22	18	0.018

Maximum working pressure: 40 bar

BPLM-M

Nut

Nickel-plated brass

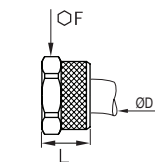

ØD	C		F	L	Kg
2.7x4	M6x0.50	BPL4M-1	8	8	0.003
4x6	M8x0.75	BPL6M-1	9	9	0.006
6x8	M12x1	BPL8M-1	14	10.5	0.008
8x10	M14x1	BPL10M-1	16	11.5	0.012
10x12	M16x1	BPL12M-1	18	13	0.014

0164

Adaptor, Male NPT/Female BSPP Thread

Nickel-plated brass

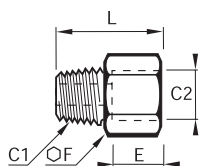

C1	C2		E	F	L	Kg
NPT1/8	G1/8	0164 11 10 99	7.5	14	20	0.015
NPT1/4	G1/4	0164 14 13 99	11	17	27.5	0.028
NPT3/8	G3/8	0164 18 17 99	11.5	22	28.5	0.044

Maximum working pressure: see page 9-6, brass adaptors.