

SUCTION CUPS / Flat

VF Series

Features and Strengths

Specifically designed for flat and curved surface
Available to handle multiple objects with the same suction cup

Advantages

Strong lifting force for both vertical and horizontal application
Stable gripping without sliding and shaking

Application

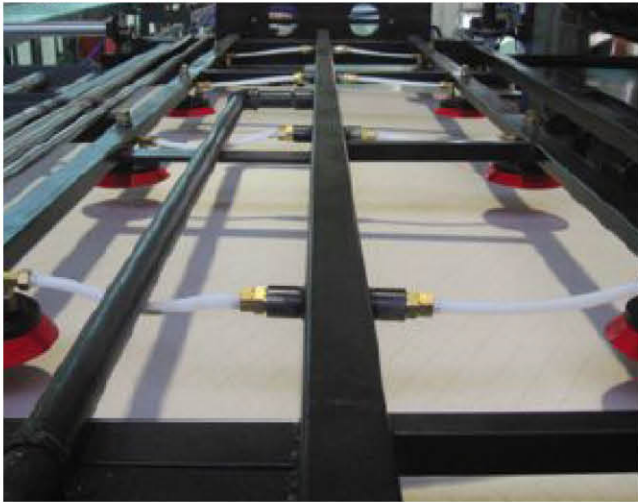

Examples of use

Metal sheet, Veneer sheets, Glass, Electronic components

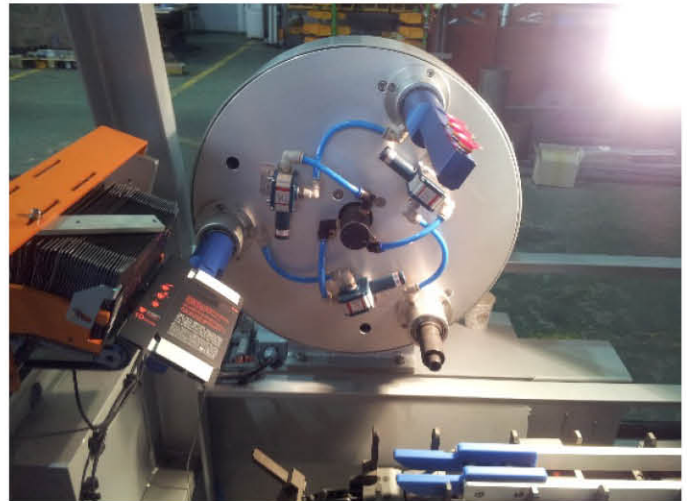

Available size option

Model	Description	Model	Description
VF15	Flat suction cup, Ø15	VF75	Flat suction cup, Ø75
VF20	Flat suction cup, Ø20	VF90	Flat suction cup, Ø90
VF25	Flat suction cup, Ø25	VF110	Flat suction cup, Ø110
VF30	Flat suction cup, Ø30	VF150	Flat suction cup, Ø150
VF40	Flat suction cup, Ø40	VF200	Flat suction cup, Ø200
VF50	Flat suction cup, Ø50	VF300	Flat suction cup, Ø300
VF50x2	Flat suction cup, Ø50		



I Recommended Lifting Force (Max.)

Model	Volume (cm ³)	Lifting Force (Kg) - Perpendicular			Lifting Force (Kg) - Parallel			Page
		- 20 kPa	- 60 kPa	- 90 kPa	- 20 kPa	- 60 kPa	- 90 kPa	
VF15	0.037	0.35	0.86	1.12	0.35	0.66	0.76	448
VF20	1.00	0.61	1.47	1.93	0.51	0.81	0.86	450
VF25	1.10	0.91	1.98	2.55	0.81	0.91	1.02	452
VF30	2.00	1.22	2.55	3.16	1.12	1.63	2.04	454
VF40	4.80	2.04	4.08	5.10	1.53	2.55	3.06	456
VF50	10.00	3.67	7.55	9.79	2.44	4.08	5.10	458
VF50x2	10.00	3.67	7.55	9.79	2.44	4.08	5.10	460
VF75	20.00	8.16	20.40	27.55	6.12	11.22	14.28	462
VF90	50.00	10.20	27.83	37.41	8.84	15.98	19.72	464
VF110	70.00	14.28	42.58	57.14	14.28	25.51	30.61	466
VF150	160.00	30.61	86.73	112.24	25.51	61.22	81.63	468
VF200	460.00	76.53	193.87	275.51	38.30	96.90	137.50	470
VF300	820.00	163	438	653	135	307	476	472

※ The lifting force above does not include safety factor

SUCTION CUPS / Flat

VF15

Features and Strengths

Specifically designed for flat and curved surface
Available to handle multiple objects with the same suction cup

Examples of use

Metal sheet, Veneer sheets, Glass, Electronic components



Recommended Lifting Force (Max.)

Model	Volume (cm ³)	Lifting Force (Kg) - Perpendicular			Lifting Force (Kg) - Parallel		
		- 20 kPa	- 60 kPa	- 90 kPa	- 20 kPa	- 60 kPa	- 90 kPa
VF15	0.037	0.35	0.86	1.12	0.35	0.66	0.76

※ The lifting force above does not include safety factor

Material Specifications

Material	Hardness Shore (°)	Color	Temperature (°C)
NBR	60	Black	-20~110
Silicone	55	Red	-70~200
White Silicone	55	Translucent White	-70~200
White Silicone (FDA)	55	Translucent White	-70~200
High temp. Silicone	50	Blue	-70~280
Conductive Silicone	70	Smoky Black	-45~90
Urethane	60	Dark Green	0~100
Mark Free	75	Black	-10~100

Material Resistance

Description	NBR	Silicone	White Silicone	High temp. Silicone	Conductive Silicone	Urethane	Mark Free
Wear Resistance	Excellent	Good	Good	Good	Good	Excellent	Good
Oil	Excellent	Poor	Poor	Poor	Poor	Excellent	Excellent
Weather / Ozone	Fair	Excellent	Excellent	Excellent	Excellent	Excellent	Excellent
Alcohol	Good	Good	Good	Good	Good	Fair	Good
Acid	Fair	Poor	Poor	Poor	Poor	Poor	Excellent

Dimension

[Unit : mm]

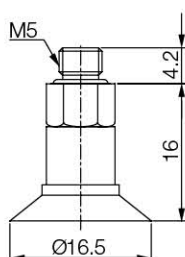

[With M5M fitting]

Build an Ordering No.

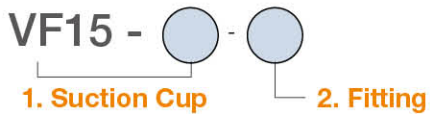

1. Suction cup	Description	Symbol
	Flat suction cup, 15mm diameter, Nitrile (NBR)	VF15-N
	Flat suction cup, 15mm diameter, Silicone	VF15-S
	Flat suction cup, 15mm diameter, White silicone	VF15-WS
	Flat suction cup, 15mm diameter, White silicone (FDA)	VF15-WS (FDA)
	Flat suction cup, 15mm diameter, High temperature silicone	VF15-HS
	Flat suction cup, 15mm diameter, Conductive silicone	VF15-CS
	Flat suction cup, 15mm diameter, Urethane	VF15-U
	Flat suction cup, 15mm diameter, Mark free	VF15-A

2. Fitting	Description	Symbol
	Fitting, M5 male	M5M
	Efficiency valve, Fitting, M5 male	M5M-EV

Spare Parts – Rubber Parts

Part No.	Description	Weight (g)	Color
VF15-N	Flat suction cup, 15mm diameter, Nitrile (NBR)	0.73	Black
VF15-S	Flat suction cup, 15mm diameter, Silicone	0.65	Red
VF15-WS	Flat suction cup, 15mm diameter, White silicone	0.64	Translucent White
VF15-WS (FDA)	Flat suction cup, 15mm diameter, White silicone (FDA)	0.64	Translucent White
VF15-HS	Flat suction cup, 15mm diameter, High temperature silicone	0.66	Blue
VF15-CS	Flat suction cup, 15mm diameter, Conductive silicone	0.64	Smoky Black
VF15-U	Flat suction cup, 15mm diameter, Urethane	0.70	Dark Green
VF15-A	Flat suction cup, 15mm diameter, Mark free	0.84	Black

Dimension

[Unit : mm]

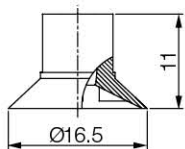

[Rubber Part]

Spare Parts – Fittings

Part No. (Code No.)	Fitting size	Description	Weight (g)
350 000 3102	M5M	M5 male	2.52
350 010 3102	M5M-EV	Efficiency valve, M5 male	2.63

SUCTION CUPS / Flat

VF20



Features and Strengths

Specifically designed for flat and curved surface
Available to handle multiple objects with the same suction cup

Examples of use

Metal sheet, Veneer sheets, Glass, Electronic components



Recommended Lifting Force (Max.)

Model	Volume (cm ³)	Lifting Force (Kg) - Perpendicular			Lifting Force (Kg) - Parallel		
		- 20 kPa	- 60 kPa	- 90 kPa	- 20 kPa	- 60 kPa	- 90 kPa
VF20	1.00	0.61	1.47	1.93	0.51	0.81	0.86

※ The lifting force above does not include safety factor

Material Specifications

Material	Hardness Shore (°)	Color	Temperature (°C)
NBR	60	Black	-20~110
Silicone	55	Red	-70~200
White Silicone	55	Translucent White	-70~200
White Silicone (FDA)	55	Translucent White	-70~200
High temp. Silicone	50	Blue	-70~280
Conductive Silicone	70	Smoky Black	-45~90
Urethane	60	Dark Green	0~100
Mark Free	75	Black	-10~100

Material Resistance

Description	NBR	Silicone	White Silicone	High temp. Silicone	Conductive Silicone	Urethane	Mark Free
Wear Resistance	Excellent	Good	Good	Good	Good	Excellent	Good
Oil	Excellent	Poor	Poor	Poor	Poor	Excellent	Excellent
Weather / Ozone	Fair	Excellent	Excellent	Excellent	Excellent	Excellent	Excellent
Alcohol	Good	Good	Good	Good	Good	Fair	Good
Acid	Fair	Poor	Poor	Poor	Poor	Poor	Excellent

Dimension

[Unit : mm]

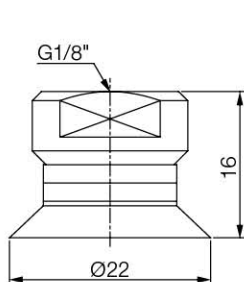

[With 18F fitting]

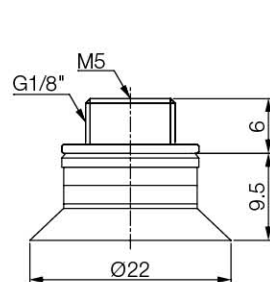

[With M518MF fitting]

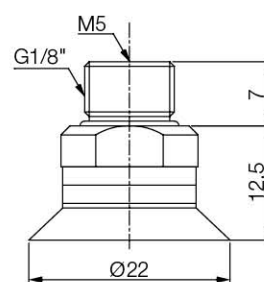

[With M518MFO fitting]

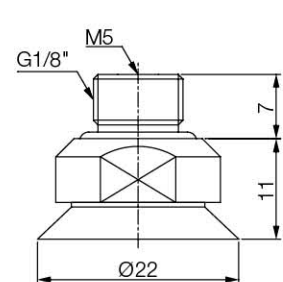

[With M518MFX fitting]

Build an Ordering No.

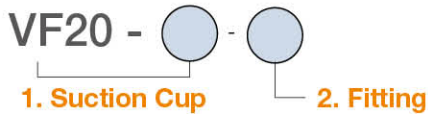

1. Suction cup	Description	Symbol
	Flat suction cup, 20mm diameter, Nitrile (NBR)	VF20-N
	Flat suction cup, 20mm diameter, Silicone	VF20-S
	Flat suction cup, 20mm diameter, White silicone	VF20-WS
	Flat suction cup, 20mm diameter, White silicone (FDA)	VF20-WS (FDA)
	Flat suction cup, 20mm diameter, High temperature silicone	VF20-HS
	Flat suction cup, 20mm diameter, Conductive silicone	VF20-CS
	Flat suction cup, 20mm diameter, Urethane	VF20-U
	Flat suction cup, 20mm diameter, Mark free	VF20-A

2. Fitting	Description	Symbol
	Fitting, G1/8 male - M5 female	M518MF
	Fitting, G1/8 male - M5 female, Mesh filter	M-M518MF
	Efficiency valve, Fitting, G1/8 Male - M5 female	M518MF-EV
	Fitting, G1/8 male - M5 female, Button valve	M518MF-BV
	Fitting, G1/8 male - M5 female, Old profile	M518MFO
	Fitting, G1/8 male - M5 female, Old profile, Mesh filter	M-M518MFO
	Efficiency valve, Fitting, G1/8 Male - M5 female, Old profile	M518MFO-EV
	Fitting, G1/8 male - M5 female, For silicone material	M518MFX*
	Fitting, G1/8 female	18F
	Fitting, G1/8 female, Mesh filter	M-18F
	Efficiency valve, Fitting, G1/8 female	18F-EV
	Fitting, G1/8 female, Button valve	18F-BV

※ M518MFX* is available only for Silicone material

Spare Parts – Rubber Parts

Part No.	Description	Weight (g)	Color
VF20-N	Flat suction cup, 20mm diameter, Nitrile (NBR)	1.31	Black
VF20-S	Flat suction cup, 20mm diameter, Silicone	1.23	Red
VF20-WS	Flat suction cup, 20mm diameter, White silicone	1.23	Translucent White
VF20-WS (FDA)	Flat suction cup, 20mm diameter, White silicone (FDA)	1.23	Translucent White
VF20-HS	Flat suction cup, 20mm diameter, High temperature silicone	1.23	Blue
VF20-CS	Flat suction cup, 20mm diameter, Conductive silicone	1.29	Smoky Black
VF20-U	Flat suction cup, 20mm diameter, Urethane	1.32	Dark Green
VF20-A	Flat suction cup, 20mm diameter, Mark free	1.48	Black

Dimension

[Unit : mm]

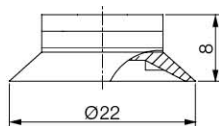

[Rubber Part]

Spare Parts – Fittings

Part No.	Part No.	Description	Weight (g)
350 000 3209	M518MF	G1/8 male - M5 female	1.82
350 000 5209	M518MF-F	G1/8 male - M5 female, Mesh filter	1.92
350 010 4209	M518MF-EV	Efficiency valve, G1/8 Male - M5 female	1.94
350 020 4209	M518MF-BV	G1/8 male - M5 female, Button valve	2.24
350 000 1209	M518MFO	G1/8 male - M5 female, Old profile	2.88
350 000 1109	M518MFO-F	G1/8 male - M5 female, Old profile, Mesh filter	2.94
350 010 1209	M518MFO-EV	Efficiency valve, G1/8 Male - M5 female, Old profile	2.87
350 000 3229	M518MFX	G1/8 male - M5 female, For silicone material	3.71
350 000 3310	18F	G1/8 female	3.23
350 000 4310	18F-F	G1/8 female, Mesh filter	3.30
350 010 3310	18F-EV	Efficiency valve, G1/8 female	3.34
350 020 3310	18F-BV	G1/8 female, Button valve	3.59

SUCTION CUPS / Flat

VF25



Features and Strengths

Specifically designed for flat and curved surface
Available to handle multiple objects with the same suction cup

Examples of use

Metal sheet, Veneer sheets, Glass, Electronic components



Recommended Lifting Force (Max.)

Model	Volume (cm ³)	Lifting Force (Kg) - Perpendicular			Lifting Force (Kg) - Parallel		
		- 20 kPa	- 60 kPa	- 90 kPa	- 20 kPa	- 60 kPa	- 90 kPa
VF25	1.10	0.91	1.98	2.55	0.81	0.91	1.02

※ The lifting force above does not include safety factor

Material Specifications

Material	Hardness Shore (°)	Color	Temperature (°C)
NBR	60	Black	-20~110
Silicone	55	Red	-70~200
White Silicone	55	Translucent White	-70~200
White Silicone (FDA)	55	Translucent White	-70~200
High temp. Silicone	50	Blue	-70~280
Conductive Silicone	70	Smoky Black	-45~90
Urethane	60	Dark Green	0~100
Mark Free	75	Black	-10~100

Material Resistance

Description	NBR	Silicone	White Silicone	High temp. Silicone	Conductive Silicone	Urethane	Mark Free
Wear Resistance	Excellent	Good	Good	Good	Good	Excellent	Good
Oil	Excellent	Poor	Poor	Poor	Poor	Excellent	Excellent
Weather / Ozone	Fair	Excellent	Excellent	Excellent	Excellent	Excellent	Excellent
Alcohol	Good	Good	Good	Good	Good	Fair	Good
Acid	Fair	Poor	Poor	Poor	Poor	Poor	Excellent

Dimension

[Unit : mm]

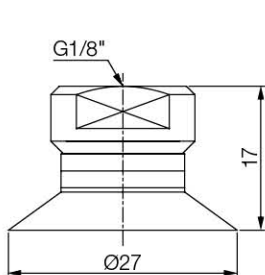

[With 18F fitting]

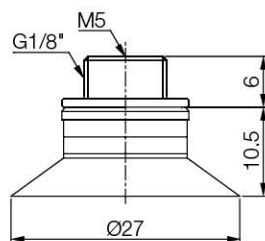

[With M518MF fitting]

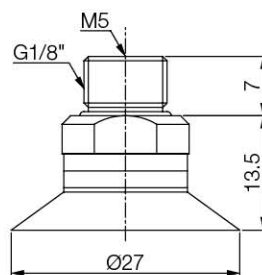

[With M518MFO fitting]

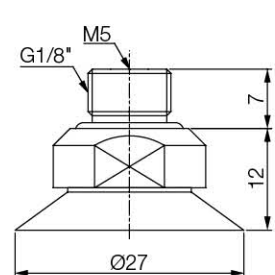

[With M518MFX fitting]

I Build an Ordering No.

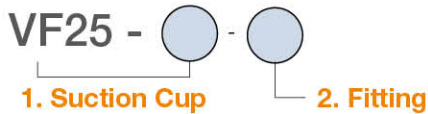

1. Suction cup	Description	Symbol
	Flat suction cup, 25mm diameter, Nitrile (NBR)	VF25-N
	Flat suction cup, 25mm diameter, Silicone	VF25-S
	Flat suction cup, 25mm diameter, White silicone	VF25-WS
	Flat suction cup, 25mm diameter, White silicone (FDA)	VF25-WS (FDA)
	Flat suction cup, 25mm diameter, High temperature silicone	VF25-HS
	Flat suction cup, 25mm diameter, Conductive silicone	VF25-CS
	Flat suction cup, 25mm diameter, Urethane	VF25-U
	Flat suction cup, 25mm diameter, Mark free	VF25-A

2. Fitting	Description	Symbol
	Fitting, G1/8 male - M5 female	M518MF
	Fitting, G1/8 male - M5 female, Mesh filter	M-M518MF
	Efficiency valve, Fitting, G1/8 Male - M5 female	M518MF-EV
	Fitting, G1/8 male - M5 female, Button valve	M518MF-BV
	Fitting, G1/8 male - M5 female, Old profile	M518MFO
	Fitting, G1/8 male - M5 female, Old profile, Mesh filter	M-M518MFO
	Efficiency valve, Fitting, G1/8 Male - M5 female, Old profile	M518MFO-EV
	Fitting, G1/8 male - M5 female, For silicone material	M518MFX*
	Fitting, G1/8 female	18F
	Fitting, G1/8 female, Mesh filter	M-18F
	Efficiency valve, Fitting, G1/8 female	18F-EV
	Fitting, G1/8 female, Button valve	18F-BV

※ M518MFX* is available only for Silicone material.

I Spare Parts – Rubber Parts

Part No.	Description	Weight (g)	Color
VF25-N	Flat suction cup, 25mm diameter, Nitrile (NBR)	1.63	Black
VF25-S	Flat suction cup, 25mm diameter, Silicone	1.60	Red
VF25-WS	Flat suction cup, 25mm diameter, White silicone	1.60	Translucent White
VF25-WS (FDA)	Flat suction cup, 25mm diameter, White silicone (FDA)	1.60	Translucent White
VF25-HS	Flat suction cup, 25mm diameter, High temperature silicone	1.60	Blue
VF25-CS	Flat suction cup, 25mm diameter, Conductive silicone	1.67	Smoky Black
VF25-U	Flat suction cup, 25mm diameter, Urethane	1.62	Dark Green
VF25-A	Flat suction cup, 25mm diameter, Mark free	1.98	Black

I Dimension

[Unit : mm]

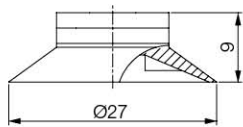

[Rubber Part]

I Spare Parts – Fittings

Part No. (Code No.)	Fitting size	Description	Weight (g)
350 000 3209	M518MF	G1/8 male - M5 female	1.82
350 000 5209	M518MF-F	G1/8 male - M5 female, Mesh filter	1.92
350 010 4209	M518MF-EV	Efficiency valve, G1/8 Male - M5 female	1.94
350 020 4209	M518MF-BV	G1/8 male - M5 female, Button valve	2.24
350 000 1209	M518MFO	G1/8 male - M5 female, Old profile	2.88
350 000 1109	M518MFO-F	G1/8 male - M5 female, Old profile, Mesh filter	2.94
350 010 1209	M518MFO-EV	Efficiency valve, G1/8 Male - M5 female, Old profile	2.87
350 000 3229	M518MFX	G1/8 male - M5 female, For silicone material	3.71
350 000 3310	18F	G1/8 female	3.23
350 000 4310	18F-F	G1/8 female, Mesh filter	3.30
350 010 3310	18F-EV	Efficiency valve, G1/8 female	3.34
350 020 3310	18F-BV	G1/8 female, Button valve	3.59

SUCTION CUPS / Flat

VF30



Features and Strengths

Specifically designed for flat and curved surface
Available to handle multiple objects with the same suction cup

Examples of use

Metal sheet, Veneer sheets, Glass, Electronic components



Recommended Lifting Force (Max.)

Model	Volume (cm ³)	Lifting Force (Kg) - Perpendicular			Lifting Force (Kg) - Parallel		
		- 20 kPa	- 60 kPa	- 90 kPa	- 20 kPa	- 60 kPa	- 90 kPa
VF30	2.00	1.22	2.55	3.16	1.12	1.63	2.04

※ The lifting force above does not include safety factor

Material Specifications

Material	Hardness Shore (°)	Color	Temperature (°C)
NBR	60	Black	-20~110
Silicone	55	Red	-70~200
White Silicone	55	Translucent White	-70~200
White Silicone (FDA)	55	Translucent White	-70~200
High temp. Silicone	50	Blue	-70~280
Conductive Silicone	70	Smoky Black	-45~90
Urethane	60	Dark Green	0~100
Mark Free	75	Black	-10~100
Polyurethane	60	Translucent Orange	0~60

Material Resistance

Description	NBR	Silicone	White Silicone	High temp. Silicone	Conductive Silicone	Urethane	Mark Free	Polyurethane
Wear Resistance	Excellent	Good	Good	Good	Good	Excellent	Good	Excellent
Oil	Excellent	Poor	Poor	Poor	Poor	Excellent	Excellent	Excellent
Weather / Ozone	Fair	Excellent	Excellent	Excellent	Excellent	Excellent	Excellent	Excellent
Alcohol	Good	Good	Good	Good	Good	Fair	Good	Fair
Acid	Fair	Poor	Poor	Poor	Poor	Poor	Excellent	Fair

Dimension

[Unit : mm]

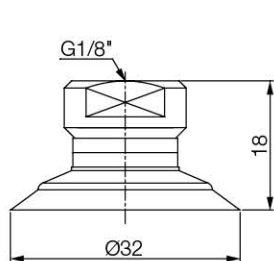

[With 18F fitting]

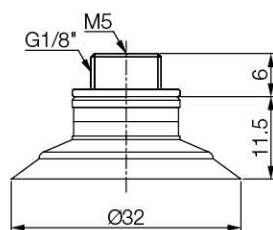

[With M518MF fitting]

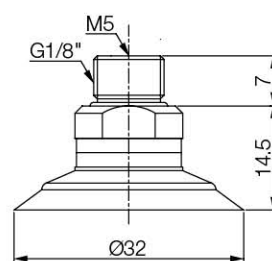

[With M518MFO fitting]

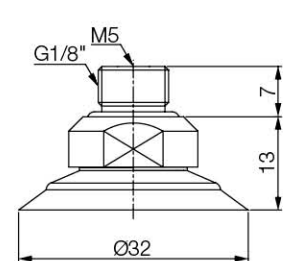

[With M518MFX fitting]

Build an Ordering No.

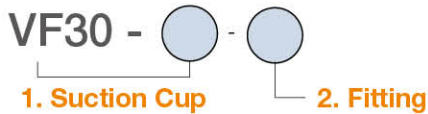

1. Suction cup	Description	Symbol
	Flat suction cup, 30mm diameter, Nitrile (NBR)	VF30-N
	Flat suction cup, 30mm diameter, Silicone	VF30-S
	Flat suction cup, 30mm diameter, White silicone	VF30-WS
	Flat suction cup, 30mm diameter, White silicone (FDA)	VF30-WS (FDA)
	Flat suction cup, 30mm diameter, High temperature silicone	VF30-HS
	Flat suction cup, 30mm diameter, Conductive silicone	VF30-CS
	Flat suction cup, 30mm diameter, Urethane	VF30-U
	Flat suction cup, 30mm diameter, Mark free	VF30-A
	Flat suction cup, 30mm diameter, Polyurethane	VF30-PU

2. Fitting	Description	Symbol
	Fitting, G1/8 male - M5 female	M518MF
	Fitting, G1/8 male - M5 female, Mesh filter	M-M518MF
	Efficiency valve, Fitting, G1/8 Male - M5 female	M518MF-EV
	Fitting, G1/8 male - M5 female, Button valve	M518MF-BV
	Fitting, G1/8 male - M5 female, Old profile	M518MFO
	Fitting, G1/8 male - M5 female, Old profile, Mesh filter	M-M518MFO
	Efficiency valve, Fitting, G1/8 Male - M5 female, Old profile	M518MFO-EV
	Fitting, G1/8 male - M5 female, For silicone material	M518MFX*
	Fitting, G1/8 female	18F
	Fitting, G1/8 female, Mesh filter	M-18F
	Efficiency valve, Fitting, G1/8 female	18F-EV
	Fitting, G1/8 female, Button valve	18F-BV

※ M518MFX* is available only for Silicone material.

Spare Parts – Rubber Parts

Part No.	Description	Weight (g)	Color
VF30-N	Flat suction cup, 30mm diameter, Nitrile (NBR)	2.55	Black
VF30-S	Flat suction cup, 30mm diameter, Silicone	2.35	Red
VF30-WS	Flat suction cup, 30mm diameter, White silicone	2.35	Translucent White
VF30-WS (FDA)	Flat suction cup, 30mm diameter, White silicone (FDA)	2.35	Translucent White
VF30-HS	Flat suction cup, 30mm diameter, High temperature silicone	2.35	Blue
VF30-CS	Flat suction cup, 30mm diameter, Conductive silicone	2.48	Smoky Black
VF30-U	Flat suction cup, 30mm diameter, Urethane	2.57	Dark Green
VF30-A	Flat suction cup, 30mm diameter, Mark free	2.98	Black
VF30-PU	Flat suction cup, 30mm diameter, Polyurethane	2.33	Translucent Orange

Dimension

[Unit : mm]

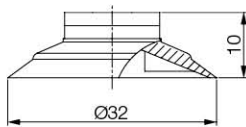

[Rubber Part]

Spare Parts – Fittings

Part No. (Code No.)	Fitting size	Description	Weight (g)
350 000 3209	M518MF	G1/8 male - M5 female	1.82
350 000 5209	M518MF-F	G1/8 male - M5 female, Mesh filter	1.92
350 010 4209	M518MF-EV	Efficiency valve, G1/8 Male - M5 female	1.94
350 020 4209	M518MF-BV	G1/8 male - M5 female, Button valve	2.25
350 000 1209	M518MFO	G1/8 male - M5 female, Old profile	2.88
350 000 1109	M518MFO-F	G1/8 male - M5 female, Old profile, Mesh filter	2.94
350 010 1209	M518MFO-EV	Efficiency valve, G1/8 Male - M5 female, Old profile	2.87
350 000 3229	M518MFX	G1/8 male - M5 female, For silicone material	3.53
350 000 3310	18F	G1/8 female	5.72
350 000 4310	18F-F	G1/8 female, Mesh filter	5.81
350 010 3310	18F-EV	Efficiency valve, G1/8 female	5.86
350 020 3310	18F-BV	G1/8 female, Button valve	6.01

SUCTION CUPS / Flat

VF40



Features and Strengths

Specifically designed for flat and curved surface
Available to handle multiple objects with the same suction cup

Examples of use

Metal sheet, Veneer sheets, Glass, Electronic components



Recommended Lifting Force (Max.)

Model	Volume (cm ³)	Lifting Force (Kg) - Perpendicular			Lifting Force (Kg) - Parallel		
		- 20 kPa	- 60 kPa	- 90 kPa	- 20 kPa	- 60 kPa	- 90 kPa
VF40	4.80	2.04	4.08	5.10	1.53	2.55	3.06

※ The lifting force above does not include safety factor

Material Specifications

Material	Hardness Shore (°)	Color	Temperature (°C)
NBR	60	Black	-20~110
Silicone	55	Red	-70~200
White Silicone	55	Translucent White	-70~200
White Silicone (FDA)	55	Translucent White	-70~200
High temp. Silicone	50	Blue	-70~280
Conductive Silicone	70	Smoky Black	-45~90
Urethane	60	Dark Green	0~100
Mark Free	75	Black	-10~100
Polyurethane	60	Translucent Orange	0~60

Material Resistance

Description	NBR	Silicone	White Silicone	High temp. Silicone	Conductive Silicone	Urethane	Mark Free	Polyurethane
Wear Resistance	Excellent	Good	Good	Good	Good	Excellent	Good	Excellent
Oil	Excellent	Poor	Poor	Poor	Poor	Excellent	Excellent	Excellent
Weather / Ozone	Fair	Excellent	Excellent	Excellent	Excellent	Excellent	Excellent	Excellent
Alcohol	Good	Good	Good	Good	Good	Fair	Good	Fair
Acid	Fair	Poor	Poor	Poor	Poor	Poor	Excellent	Fair

Dimension

[Unit : mm]

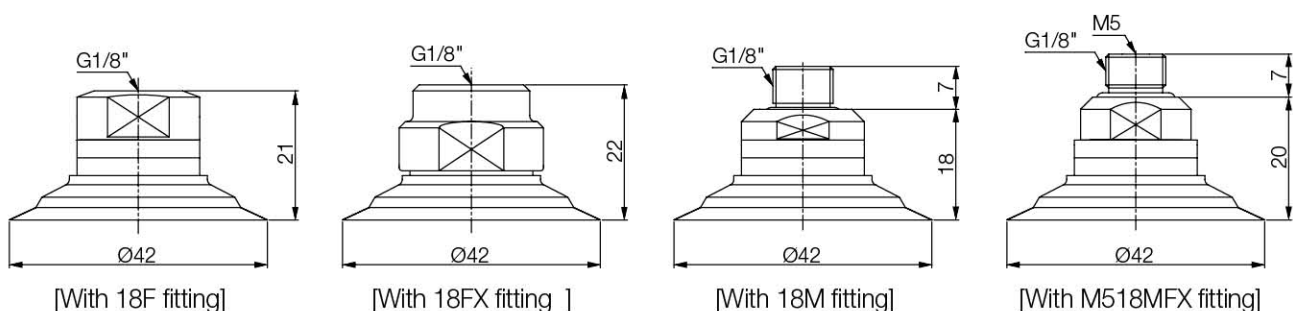

I Build an Ordering No.

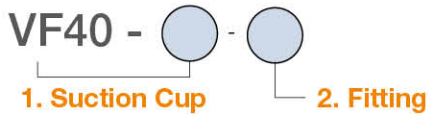

1. Suction cup	Description	Symbol
	Flat suction cup, 40mm diameter, Nitrile (NBR)	VF40-N
	Flat suction cup, 40mm diameter, Silicone	VF40-S
	Flat suction cup, 40mm diameter, White silicone	VF40-WS
	Flat suction cup, 40mm diameter, White silicone (FDA)	VF40-WS (FDA)
	Flat suction cup, 40mm diameter, High temperature silicone	VF40-HS
	Flat suction cup, 40mm diameter, Conductive silicone	VF40-CS
	Flat suction cup, 40mm diameter, Urethane	VF40-U
	Flat suction cup, 40mm diameter, Mark free	VF40-A
	Flat suction cup, 40mm diameter, Polyurethane	VF40-PU

2. Fitting	Description	Symbol
	Fitting, G1/8 female	18F
	Fitting, G1/8 female, Mesh filter	M-18F
	Efficiency valve, Fitting, G1/8 female	18F-EV
	Fitting, G1/8 female, Button valve	18F-BV
	Fitting, G1/8 female, Old profile	18FO
	Fitting, G1/8 female, Old profile, Mesh filter	M-18FO
	Fitting, G1/8 female, For silicone material	18FX*
	Fitting, G1/8 male	18M
	Fitting, G1/8 male, Mesh filter	M-18M
	Efficiency valve, Fitting, G1/8 male	18M-EV
	Fitting, G1/4 male	14M
	Fitting, G1/4 male, Mesh filter	M-14M
	Efficiency valve, Fitting, G1/4 male	14M-EV

※ 18FX* is available only for Silicone material.

I Spare Parts – Rubber Parts

Part No.	Description	Weight (g)	Color
VF40-N	Flat suction cup, 40mm diameter, Nitrile (NBR)	5.40	Black
VF40-S	Flat suction cup, 40mm diameter, Silicone	5.16	Red
VF40-WS	Flat suction cup, 40mm diameter, White silicone	5.16	Translucent White
VF40-WS (FDA)	Flat suction cup, 40mm diameter, White silicone (FDA)	5.16	Translucent White
VF40-HS	Flat suction cup, 40mm diameter, High temperature silicone	5.16	Blue
VF40-CS	Flat suction cup, 40mm diameter, Conductive silicone	5.24	Smoky Black
VF40-U	Flat suction cup, 40mm diameter, Urethane	5.42	Dark Green
VF40-A	Flat suction cup, 40mm diameter, Mark free	6.56	Black
VF40-PU	Flat suction cup, 40mm diameter, Polyurethane	4.93	Translucent Orange

I Dimension

[Unit : mm]

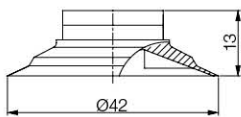

[Rubber Part]

I Spare Parts – Fittings

Part No. (Code No.)	Fitting size	Description	Weight (g)
350 000 3311	18F	G1/8 female	5.68
350 000 4311	18F-F	G1/8 female, Mesh filter	5.73
350 010 3311	18F-EV	Efficiency valve, G1/8 female	5.63
350 020 3311	18F-BV	G1/8 female, Button valve	5.86
350 000 2311	18FO	G1/8 female, Old profile	8.24
350 000 4811	18FO-F	G1/8 female, Old profile, Mesh filter	8.41
350 000 3321	18FX	G1/8 female, For silicone material	8.58
350 000 2304	18M	G1/8 male	4.93
350 000 4304	18M-F	G1/8 male, Mesh filter	5.04
350 010 2304	18M-EV	Efficiency valve, G1/8 male	5.08
350 000 3404	14M	G1/4 male	5.88
350 000 3804	14M-F	G1/4 male, Mesh filter	5.92
350 010 3404	14M-EV	Efficiency valve, G1/4 male	6.03

SUCTION CUPS / Flat

VF50



Features and Strengths

Specifically designed for flat and curved surface
Available to handle multiple objects with the same suction cup

Examples of use

Metal sheet, Veneer sheets, Glass, Electronic components



Recommended Lifting Force (Max.)

Model	Volume (cm ³)	Lifting Force (Kg) - Perpendicular			Lifting Force (Kg) - Parallel		
		- 20 kPa	- 60 kPa	- 90 kPa	- 20 kPa	- 60 kPa	- 90 kPa
VF50	10.00	3.67	7.55	9.79	2.44	4.08	5.10

※ The lifting force above does not include safety factor

Material Specifications

Material	Hardness Shore (°)	Color	Temperature (°C)
NBR	60	Black	-20~110
Silicone	55	Red	-70~200
White Silicone	55	Translucent White	-70~200
White Silicone (FDA)	55	Translucent White	-70~200
High temp. Silicone	50	Blue	-70~280
Conductive Silicone	70	Smoky Black	-45~90
Urethane	60	Dark Green	0~100
Mark Free	75	Black	-10~100
Polyurethane	60	Translucent Orange	0~60

Material Resistance

Description	NBR	Silicone	White Silicone	High temp. Silicone	Conductive Silicone	Urethane	Mark Free	Polyurethane
Wear Resistance	Excellent	Good	Good	Good	Good	Excellent	Good	Excellent
Oil	Excellent	Poor	Poor	Poor	Poor	Excellent	Excellent	Excellent
Weather / Ozone	Fair	Excellent	Excellent	Excellent	Excellent	Excellent	Excellent	Excellent
Alcohol	Good	Good	Good	Good	Good	Fair	Good	Fair
Acid	Fair	Poor	Poor	Poor	Poor	Poor	Excellent	Fair

Dimension

[Unit : mm]

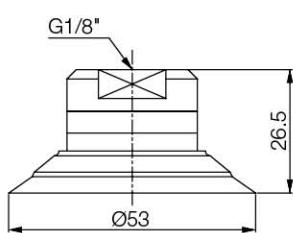

[With 18F fitting]

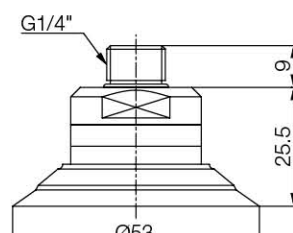

[With 14M fitting]

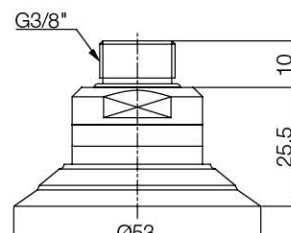

[With 38M fitting]

I Build an Ordering No.

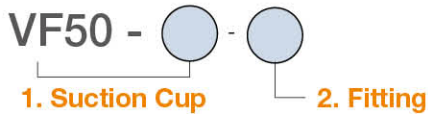

1. Suction cup	Description	Symbol
	Flat suction cup, 50mm diameter, Nitrile (NBR)	VF50-N
	Flat suction cup, 50mm diameter, Silicone	VF50-S
	Flat suction cup, 50mm diameter, White silicone	VF50-WS
	Flat suction cup, 50mm diameter, White silicone (FDA)	VF50-WS (FDA)
	Flat suction cup, 50mm diameter, High temperature silicone	VF50-HS
	Flat suction cup, 50mm diameter, Conductive silicone	VF50-CS
	Flat suction cup, 50mm diameter, Urethane	VF50-U
	Flat suction cup, 50mm diameter, Mark free	VF50-A
	Flat suction cup, 50mm diameter, Polyurethane	VF50-PU

2. Fitting	Description	Symbol
	Fitting, G1/8 female	18F
	Fitting, G1/8 female, Mesh filter	M-18F
	Efficiency valve, Fitting, G1/8 female	18F-EV
	Fitting, G1/8 female, Button valve	18F-BV
	Fitting, G1/8 female, Old profile	18FO
	Fitting, G1/8 female, Old profile, Mesh filter	M-18FO
	Efficiency valve, Fitting, G1/8 female, Old profile	18FO-EV
	Fitting, G1/4 male	14M
	Fitting, G1/4 male, Mesh filter	M-14M
	Efficiency valve, Fitting, G1/4 male	14M-EV
	Fitting, G3/8 male	38M
	Fitting, G3/8 male, Mesh filter	M-38M
	Efficiency valve, Fitting, G3/8 male	38M-EV

I Spare Parts – Rubber Parts

Part No.	Description	Weight (g)	Color
VF50-N	Flat suction cup, 50mm diameter, Nitrile (NBR)	12.25	Black
VF50-S	Flat suction cup, 50mm diameter, Silicone	11.88	Red
VF50-WS	Flat suction cup, 50mm diameter, White silicone	11.88	Translucent White
VF50-WS (FDA)	Flat suction cup, 50mm diameter, White silicone (FDA)	11.88	Translucent White
VF50-HS	Flat suction cup, 50mm diameter, High temperature silicone	11.88	Blue
VF50-CS	Flat suction cup, 50mm diameter, Conductive silicone	11.98	Smoky Black
VF50-U	Flat suction cup, 50mm diameter, Urethane	12.30	Dark Green
VF50-A	Flat suction cup, 50mm diameter, Mark free	14.20	Black
VF50-PU	Flat suction cup, 50mm diameter, Polyurethane	11.18	Translucent Orange

I Dimension

[Unit : mm]

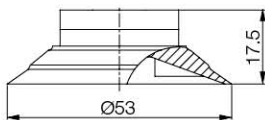

[Rubber Part]

I Spare Parts – Fittings

Part No.	Part No.	Description	Weight (g)
350 000 3312	18F	G1/8 female	14.47
350 000 4312	18F-F	G1/8 female, Mesh filter	14.58
350 010 3312	18F-EV	Efficiency valve, G1/8 female	15.81
350 020 3312	18F-BV	G1/8 female, Button valve	14.86
350 000 1312	18FO	G1/8 female, Old profile	10.12
350 000 4912	18FO-F	G1/8 female, Old profile, Mesh filter	10.2
350 010 1312	18FO-EV	Efficiency valve, G1/8 female, Old profile	10.22
350 000 3405	14M	G1/4 male	14.18
350 000 3805	14M-F	G1/4 male, Mesh filter	14.42
350 010 3405	14M-EV	Efficiency valve, G1/4 male	14.38
350 000 3505	38M	G3/8 male	18.14
350 000 3905	38M-F	G3/8 male, Mesh filter	17.75
350 010 3505	38M-EV	Efficiency valve, G3/8 male	17.53

SUCTION CUPS / Flat

VF50x2



Features and Strengths

Specifically designed for flat and curved surface
Available to handle multiple objects with the same suction cup

Examples of use

Metal sheet, Veneer sheets, Glass, Electronic components



Recommended Lifting Force (Max.)

Model	Volume (cm ³)	Lifting Force (Kg) - Perpendicular			Lifting Force (Kg) - Parallel		
		- 20 kPa	- 60 kPa	- 90 kPa	- 20 kPa	- 60 kPa	- 90 kPa
VF50x2	10.00	3.67	7.55	9.79	2.44	4.08	5.10

※ The lifting force above does not include safety factor

Material Specifications

Material	Hardness Shore (°)	Color	Temperature (°C)
NBR	60	Black	-20~110
Silicone	55	Red	-70~200
White Silicone	55	Translucent White	-70~200
White Silicone (FDA)	55	Translucent White	-70~200
High temp. Silicone	50	Blue	-70~280
Conductive Silicone	70	Smoky Black	-45~90
Urethane	60	Dark Green	0~100
Mark Free	75	Black	-10~100

Material Resistance

Description	NBR	Silicone	White Silicone	High temp. Silicone	Conductive Silicone	Urethane	Mark Free
Wear Resistance	Excellent	Good	Good	Good	Good	Excellent	Good
Oil	Excellent	Poor	Poor	Poor	Poor	Excellent	Excellent
Weather / Ozone	Fair	Excellent	Excellent	Excellent	Excellent	Excellent	Excellent
Alcohol	Good	Good	Good	Good	Good	Fair	Good
Acid	Fair	Poor	Poor	Poor	Poor	Poor	Excellent

Dimension

[Unit : mm]

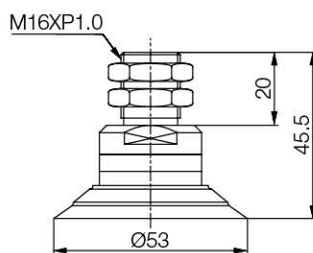

[With M16M fitting]

I Build an Ordering No.

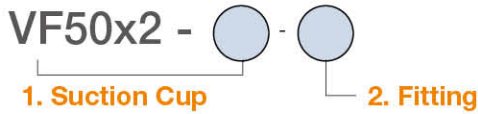

1. Suction cup	Description	Symbol
	Flat suction cup, 50mm diameter, Nitrile (NBR)	VF50x2-N
	Flat suction cup, 50mm diameter, Silicone	VF50x2-S
	Flat suction cup, 50mm diameter, White silicone	VF50x2-WS
	Flat suction cup, 50mm diameter, White silicone (FDA)	VF50x2-WS (FDA)
	Flat suction cup, 50mm diameter, High temperature silicone	VF50x2-HS
	Flat suction cup, 50mm diameter, Conductive silicone	VF50x2-CS
	Flat suction cup, 50mm diameter, Urethane	VF50x2-U
	Flat suction cup, 50mm diameter, Mark free	VF50x2-A
2. Fitting	Description	Symbol
	Fitting, M16 male	M16M

I Spare Parts – Rubber Parts

Part No.	Description	Weight (g)	Color
VF50x2-N	Flat suction cup, 50mm diameter, Nitrile (NBR)	12.25	Black
VF50x2-S	Flat suction cup, 50mm diameter, Silicone	11.88	Red
VF50x2-WS	Flat suction cup, 50mm diameter, White silicone	11.88	Translucent White
VF50x2-WS (FDA)	Flat suction cup, 50mm diameter, White silicone (FDA)	11.88	Translucent White
VF50x2-HS	Flat suction cup, 50mm diameter, High temperature silicone	11.88	Blue
VF50x2-CS	Flat suction cup, 50mm diameter, Conductive silicone	11.98	Smoky Black
VF50x2-U	Flat suction cup, 50mm diameter, Urethane	12.3	Dark Green
VF50x2-A	Flat suction cup, 50mm diameter, Mark free	14.2	Black

I Spare Parts – Fittings

Part No. (Code No.)	Fitting size	Description	Weight (g)
350 000 1405	M16M	M16 male	52.23

SUCTION CUPS / Flat

VF75



Features and Strengths

Specifically designed for flat and curved surface
Available to handle multiple objects with the same suction cup

Examples of use

Metal sheet, Veneer sheets, Glass, Electronic components



Recommended Lifting Force (Max.)

Model	Volume (cm ³)	Lifting Force (Kg) - Perpendicular			Lifting Force (Kg) - Parallel		
		- 20 kPa	- 60 kPa	- 90 kPa	- 20 kPa	- 60 kPa	- 90 kPa
VF75	20.00	8.16	20.40	27.55	6.12	11.22	14.28

※ The lifting force above does not include safety factor

Material Specifications

Material	Hardness Shore (°)	Color	Temperature (°C)
NBR	60	Black	-20~110
Silicone	55	Red	-70~200
White Silicone	55	Translucent White	-70~200
White Silicone (FDA)	55	Translucent White	-70~200
High temp. Silicone	50	Blue	-70~280
Conductive Silicone	70	Smoky Black	-45~90
Urethane	60	Dark Green	0~100
Mark Free	75	Black	-10~100
Polyurethane	60	Translucent Orange	0~60

Material Resistance

Description	NBR	Silicone	White Silicone	High temp. Silicone	Conductive Silicone	Urethane	Mark Free	Polyurethane
Wear Resistance	Excellent	Good	Good	Good	Good	Excellent	Good	Excellent
Oil	Excellent	Poor	Poor	Poor	Poor	Excellent	Excellent	Excellent
Weather / Ozone	Fair	Excellent	Excellent	Excellent	Excellent	Excellent	Excellent	Excellent
Alcohol	Good	Good	Good	Good	Good	Fair	Good	Fair
Acid	Fair	Poor	Poor	Poor	Poor	Poor	Excellent	Fair

Dimension

[Unit : mm]

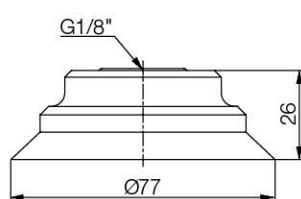

[With 18F fitting]

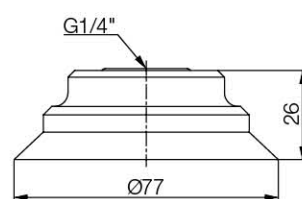

[With 14F fitting]

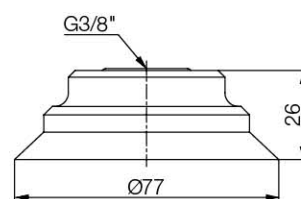

[With 38F fitting]

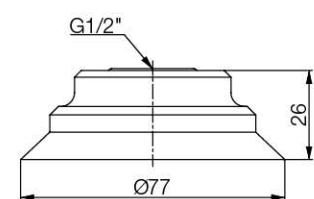

[With 12F fitting]

I Build an Ordering No.

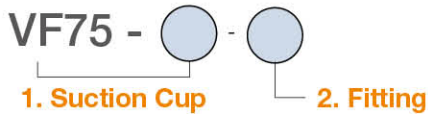

1. Suction cup	Description	Symbol
	Flat suction cup, 75mm diameter, Nitrile (NBR)	VF75-N
	Flat suction cup, 75mm diameter, Silicone	VF75-S
	Flat suction cup, 75mm diameter, White silicone	VF75-WS
	Flat suction cup, 75mm diameter, White silicone (FDA)	VF75-WS (FDA)
	Flat suction cup, 75mm diameter, High temperature silicone	VF75-HS
	Flat suction cup, 75mm diameter, Conductive silicone	VF75-CS
	Flat suction cup, 75mm diameter, Urethane	VF75-U
	Flat suction cup, 75mm diameter, Mark free	VF75-A
	Flat suction cup, 75mm diameter, Polyurethane	VF75-PU

2. Fitting	Description	Symbol
	Fitting, G1/8 female	18F
	Fitting, G1/8 female, Mesh filter	M-18F
	Fitting, G1/8 female, Button valve	18F-BV
	Fitting, G1/4 female	14F
	Fitting, G1/4 female, Mesh filter	M-14F
	Fitting, G3/8 female	38F
	Fitting, G3/8 female, Mesh filter	M-38F
	Fitting, G1/2 female	12F
	Fitting, G1/2 female, Mesh filter	M-12F

I Spare Parts – Rubber Parts

Part No.	Description	Weight (g)	Color
VF75-N	Flat suction cup, 75mm diameter, Nitrile (NBR)	47.72	Black
VF75-S	Flat suction cup, 75mm diameter, Silicone	46.07	Red
VF75-WS	Flat suction cup, 75mm diameter, White silicone	46.07	Translucent White
VF75-WS (FDA)	Flat suction cup, 75mm diameter, White silicone (FDA)	46.07	Translucent White
VF75-HS	Flat suction cup, 75mm diameter, High temperature silicone	46.07	Blue
VF75-CS	Flat suction cup, 75mm diameter, Conductive silicone	46.17	Smoky Black
VF75-U	Flat suction cup, 75mm diameter, Urethane	47.75	Dark Green
VF75-A	Flat suction cup, 75mm diameter, Mark free	53.46	Black
VF75-PU	Flat suction cup, 75mm diameter, Polyurethane	45.72	Translucent Orange

I Dimension

[Unit : mm]

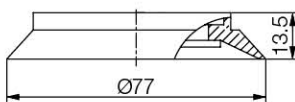

[Rubber Part]

I Spare Parts – Fittings

Part No. (Code No.)	Fitting size	Description	Weight (g)
350 000 3323	18F	G1/8 female	59.36
350 000 4323	18F-F	G1/8 female, Mesh filter	59.76
350 020 3323	18F-BV	G1/8 female, Button valve	83.56
350 000 3423	14F	G1/4 female	56.92
350 000 3823	14F-F	G1/4 female, Mesh filter	57.32
350 000 3523	38F	G3/8 female	55.08
350 000 3923	38F-F	G3/8 female, Mesh filter	55.48
350 000 3623	12F	G1/2 female	51.50
350 000 4023	12F-F	G1/2 female, Mesh filter	51.90

SUCTION CUPS / Flat

VF90

Features and Strengths

Specifically designed for flat and curved surface
Available to handle multiple objects with the same suction cup

Examples of use

Metal sheet, Veneer sheets, Glass, Electronic components



Recommended Lifting Force (Max.)

Model	Volume (cm ³)	Lifting Force (Kg) - Perpendicular			Lifting Force (Kg) - Parallel		
		- 20 kPa	- 60 kPa	- 90 kPa	- 20 kPa	- 60 kPa	- 90 kPa
VF90	50.00	10.20	27.83	37.41	8.84	15.98	19.72

※ The lifting force above does not include safety factor

Material Specifications

Material	Hardness Shore (°)	Color	Temperature (°C)
Polyurethane	60	Translucent Orange	0~60

Material Resistance

Description	Polyurethane
Wear Resistance	Excellent
Oil	Excellent
Weather / Ozone	Excellent
Alcohol	Fair
Acid	Fair

Dimension

[Unit : mm]

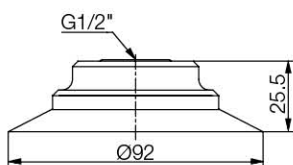

[With 12F fitting]

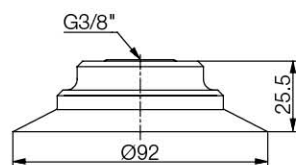

[With 38F fitting]

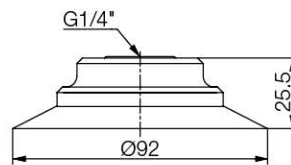

[With 14F fitting]

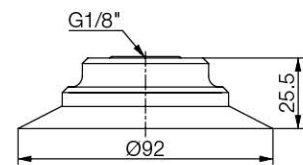

[With 18F fitting]

Build an Ordering No.

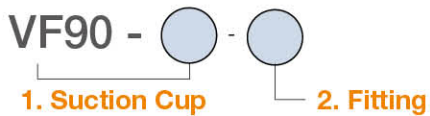

1. Suction cup	Description	Symbol
	Flat suction cup, 90mm diameter, Polyurethane	VF90-PU
2. Fitting	Description	Symbol
	Fitting, G1/8 female	18F
	Fitting, G1/8 female, Mesh filter	M-18F
	Fitting, G1/8 female, Button valve	18F-BV
	Fitting, G1/4 female	14F
	Fitting, G1/4 female, Mesh filter	M-14F
	Fitting, G3/8 female	38F
	Fitting, G3/8 female, Mesh filter	M-38F
	Fitting, G1/2 female	12F
	Fitting, G1/2 female, Mesh filter	M-12F

Spare Parts – Rubber Parts

Part No.	Description	Weight (g)	Color
VF90-PU	Flat suction cup, 90mm diameter, Polyurethane	48.90	Translucent Orange

Dimension

[Unit : mm]

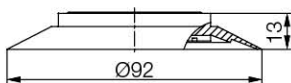

[Rubber Part]

Spare Parts – Fittings

Part No. (Code No.)	Fitting size	Description	Weight (g)
350 000 3323	18F	G1/8 female	59.36
350 000 4323	18F-F	G1/8 female, Mesh filter	59.76
350 020 3323	18F-BV	G1/8 female, Button valve	83.56
350 000 3423	14F	G1/4 female	56.92
350 000 3823	14F-F	G1/4 female, Mesh filter	57.32
350 000 3523	38F	G3/8 female	55.08
350 000 3923	38F-F	G3/8 female, Mesh filter	55.48
350 000 3623	12F	G1/2 female	51.50
350 000 4023	12F-F	G1/2 female, Mesh filter	51.90

SUCTION CUPS / Flat

VF110



Features and Strengths

Specifically designed for flat and curved surface
Available to handle multiple objects with the same suction cup

Examples of use

Metal sheet, Veneer sheets, Glass, Electronic components



Recommended Lifting Force (Max.)

Model	Volume (cm ³)	Lifting Force (Kg) - Perpendicular			Lifting Force (Kg) - Parallel		
		- 20 kPa	- 60 kPa	- 90 kPa	- 20 kPa	- 60 kPa	- 90 kPa
VF110	70.00	14.28	42.58	57.14	14.28	25.51	30.61

※ The lifting force above does not include safety factor

Material Specifications

Material	Hardness Shore (°)	Color	Temperature (°C)
NBR	60	Black	-20~110
Silicone	55	Red	-70~200
White Silicone	55	Translucent White	-70~200
White Silicone (FDA)	55	Translucent White	-70~200
High temp. Silicone	50	Blue	-70~280
Conductive Silicone	70	Smoky Black	-45~90
Urethane	60	Dark Green	0~100
Mark Free	75	Black	-10~100

Material Resistance

Description	NBR	Silicone	White Silicone	High temp. Silicone	Conductive Silicone	Urethane	Mark Free
Wear Resistance	Excellent	Good	Good	Good	Good	Excellent	Good
Oil	Excellent	Poor	Poor	Poor	Poor	Excellent	Excellent
Weather / Ozone	Fair	Excellent	Excellent	Excellent	Excellent	Excellent	Excellent
Alcohol	Good	Good	Good	Good	Good	Fair	Good
Acid	Fair	Poor	Poor	Poor	Poor	Poor	Excellent

Dimension

[Unit : mm]

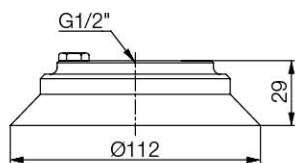

[With 12F fitting]

I Build an Ordering No.

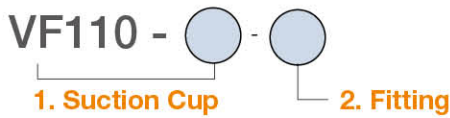

1. Suction cup	Description	Symbol
	Flat suction cup, 110mm diameter, Nitrile (NBR)	VF110-N
	Flat suction cup, 110mm diameter, Silicone	VF110-S
	Flat suction cup, 110mm diameter, White silicone	VF110-WS
	Flat suction cup, 110mm diameter, White silicone (FDA)	VF110-WS (FDA)
	Flat suction cup, 110mm diameter, High temperature silicone	VF110-HS
	Flat suction cup, 110mm diameter, Conductive silicone	VF110-CS
	Flat suction cup, 110mm diameter, Urethane	VF110-U
	Flat suction cup, 110mm diameter, Mark free	VF110-A

2. Fitting	Description	Symbol
	Fitting, G1/2 female	12F
	Fitting, G1/2 female, Mesh filter	M-12F
	Fitting, G1/2 female, Button valve	12F-BV

I Spare Parts – Rubber Parts

Part No.	Description	Weight (g)	Color
VF110-N	Flat suction cup, 110mm diameter, Nitrile (NBR)	126.8	Black
VF110-S	Flat suction cup, 110mm diameter, Silicone	123.04	Red
VF110-WS	Flat suction cup, 110mm diameter, White silicone	121.27	Translucent White
VF110-WS (FDA)	Flat suction cup, 110mm diameter, White silicone (FDA)	121.27	Translucent White
VF110-HS	Flat suction cup, 110mm diameter, High temperature silicone	131.12	Blue
VF110-CS	Flat suction cup, 110mm diameter, Conductive silicone	125.57	Smoky Black
VF110-U	Flat suction cup, 110mm diameter, Urethane	127.6	Dark Green
VF110-A	Flat suction cup, 110mm diameter, Mark free	139.96	Black

I Dimension

[Unit : mm]

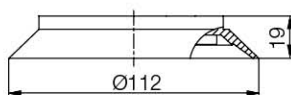

[Rubber Part]

I Spare Parts – Fittings

Part No. (Code No.)	Fitting size	Description	Weight (g)
350 000 3614	12F	G1/2 female	103.70
350 000 4014	12F-F	G1/2 female, Mesh filter	104.50
350 020 3614	12F-BV	G1/2 female, Button valve	115.54

SUCTION CUPS / Flat

VF150



Features and Strengths

Specifically designed for flat and curved surface
Available to handle multiple objects with the same suction cup

Examples of use

Metal sheet, Veneer sheets, Glass, Electronic components



Recommended Lifting Force (Max.)

Model	Volume (cm ³)	Lifting Force (Kg) - Perpendicular			Lifting Force (Kg) - Parallel		
		- 20 kPa	- 60 kPa	- 90 kPa	- 20 kPa	- 60 kPa	- 90 kPa
VF150	160.00	30.61	86.73	112.24	25.51	61.22	81.63

※ The lifting force above does not include safety factor

Material Specifications

Material	Hardness Shore (°)	Color	Temperature (°C)
NBR	60	Black	-20~110
Silicone	55	Red	-70~200
White Silicone	55	Translucent White	-70~200
White Silicone (FDA)	55	Translucent White	-70~200
High temp. Silicone	50	Blue	-70~280
Conductive Silicone	70	Smoky Black	-45~90
Urethane	60	Dark Green	0~100
Mark Free	75	Black	-10~100

Material Resistance

Description	NBR	Silicone	White Silicone	High temp. Silicone	Conductive Silicone	Urethane	Mark Free
Wear Resistance	Excellent	Good	Good	Good	Good	Excellent	Good
Oil	Excellent	Poor	Poor	Poor	Poor	Excellent	Excellent
Weather / Ozone	Fair	Excellent	Excellent	Excellent	Excellent	Excellent	Excellent
Alcohol	Good	Good	Good	Good	Good	Fair	Good
Acid	Fair	Poor	Poor	Poor	Poor	Poor	Excellent

Dimension

[Unit : mm]

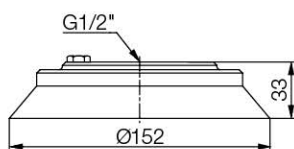

[With 12F fitting]

I Build an Ordering No.

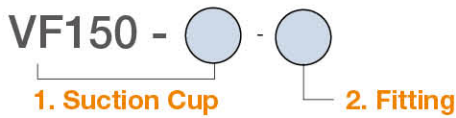

1. Suction cup	Description	Symbol
	Flat suction cup, 150mm diameter, Nitrile (NBR)	VF150-N
	Flat suction cup, 150mm diameter, Silicone	VF150-S
	Flat suction cup, 150mm diameter, White silicone	VF150-WS
	Flat suction cup, 150mm diameter, White silicone (FDA)	VF150-WS (FDA)
	Flat suction cup, 150mm diameter, High temperature silicone	VF150-HS
	Flat suction cup, 150mm diameter, Conductive silicone	VF150-CS
	Flat suction cup, 150mm diameter, Urethane	VF150-U
	Flat suction cup, 150mm diameter, Mark free	VF150-A

2. Fitting	Description	Symbol
	Fitting, G1/2 female	12F
	Fitting, G1/2 female, Mesh filter	M-12F
	Fitting, G1/2 female, Button valve	12F-BV

I Spare Parts – Rubber Parts

Part No.	Description	Weight (g)	Color
VF150-N	Flat suction cup, 150mm diameter, Nitrile (NBR)	351	Black
VF150-S	Flat suction cup, 150mm diameter, Silicone	333.9	Red
VF150-WS	Flat suction cup, 150mm diameter, White silicone	340.96	Translucent White
VF150-WS (FDA)	Flat suction cup, 150mm diameter, White silicone (FDA)	340.96	Translucent White
VF150-HS	Flat suction cup, 150mm diameter, High temperature silicone	362.96	Blue
VF150-CS	Flat suction cup, 150mm diameter, Conductive silicone	347.59	Smoky Black
VF150-U	Flat suction cup, 150mm diameter, Urethane	363.63	Dark Green
VF150-A	Flat suction cup, 150mm diameter, Mark free	375.48	Black

I Dimension

[Unit : mm]

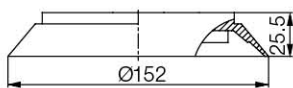

[Rubber Part]

I Spare Parts – Fittings

Part No. (Code No.)	Fitting size	Description	Weight (g)
350 000 3615	12F	G1/2 female	198.93
350 000 4015	12F-F	G1/2 female, Mesh filter	199.73
350 020 3615	12F-BV	G1/2 female, Button valve	314.47

SUCTION CUPS / Flat

VF200



Features and Strengths

Specifically designed for flat and curved surface
Available to handle multiple objects with the same suction cup

Examples of use

Metal sheet, Veneer sheets, Glass, Electronic components



Recommended Lifting Force (Max.)

Model	Volume (cm ³)	Lifting Force (Kg) - Perpendicular			Lifting Force (Kg) - Parallel		
		- 20 kPa	- 60 kPa	- 90 kPa	- 20 kPa	- 60 kPa	- 90 kPa
VF200	460.00	76.53	193.87	275.51	38.30	96.90	137.50

※ The lifting force above does not include safety factor

Material Specifications

Material	Hardness Shore (°)	Color	Temperature (°C)
NBR	60	Black	-20~110
Silicone	55	Red	-70~200
White Silicone	55	Translucent White	-70~200
White Silicone (FDA)	55	Translucent White	-70~200
High temp. Silicone	50	Blue	-70~280
Conductive Silicone	70	Smoky Black	-45~90
Urethane	60	Dark Green	0~100
Mark Free	75	Black	-10~100

Material Resistance

Description	NBR	Silicone	White Silicone	High temp. Silicone	Conductive Silicone	Urethane	Mark Free
Wear Resistance	Excellent	Good	Good	Good	Good	Excellent	Good
Oil	Excellent	Poor	Poor	Poor	Poor	Excellent	Excellent
Weather / Ozone	Fair	Excellent	Excellent	Excellent	Excellent	Excellent	Excellent
Alcohol	Good	Good	Good	Good	Good	Fair	Good
Acid	Fair	Poor	Poor	Poor	Poor	Poor	Excellent

Dimension

[Unit : mm]

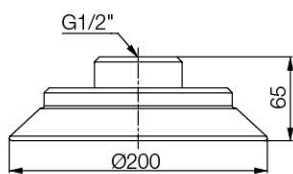

[With 12F fitting]

Build an Ordering No.

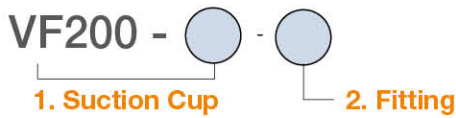

1. Suction cup	Description	Symbol
	Flat suction cup, 200mm diameter, Nitrile (NBR)	VF200-N
	Flat suction cup, 200mm diameter, Silicone	VF200-S
	Flat suction cup, 200mm diameter, White silicone	VF200-WS
	Flat suction cup, 200mm diameter, White silicone (FDA)	VF200-WS (FDA)
	Flat suction cup, 200mm diameter, High temperature silicone	VF200-HS
	Flat suction cup, 200mm diameter, Conductive silicone	VF200-CS
	Flat suction cup, 200mm diameter, Urethane	VF200-U
	Flat suction cup, 200mm diameter, Mark free	VF200-A

2. Fitting	Description	Symbol
	Fitting, G1/2 female	12F
	Fitting, G1/2 female, Mesh filter	M-12F

Spare Parts – Rubber Parts

Part No.	Description	Weight (g)	Color
VF200-N	Flat suction cup, 200mm diameter, Nitrile (NBR)	748	Black
VF200-S	Flat suction cup, 200mm diameter, Silicone	725	Red
VF200-WS	Flat suction cup, 200mm diameter, White silicone	731.6	Translucent White
VF200-WS (FDA)	Flat suction cup, 200mm diameter, White silicone (FDA)	731.6	Translucent White
VF200-HS	Flat suction cup, 200mm diameter, High temperature silicone	763.5	Blue
VF200-CS	Flat suction cup, 200mm diameter, Conductive silicone	740.74	Smoky Black
VF200-U	Flat suction cup, 200mm diameter, Urethane	769.92	Dark Green
VF200-A	Flat suction cup, 200mm diameter, Mark free	778.13	Black

Dimension

[Unit : mm]

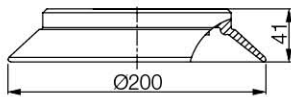

[Rubber Part]

Spare Parts – Fittings

Part No. (Code No.)	Fitting size	Description	Weight (g)
350 000 3616	12F	G1/2 female	555
350 000 4016	12F-F	G1/2 female, Mesh filter	555.3

SUCTION CUPS / Flat

VF300



Features and Strengths

Specifically designed for flat and curved surface
Available to handle multiple objects with the same suction cup

Examples of use

Metal sheet, Veneer sheets, Glass, Electronic components



Recommended Lifting Force (Max.)

Model	Volume (cm ³)	Lifting Force (Kg) - Perpendicular			Lifting Force (Kg) - Parallel		
		- 20 kPa	- 60 kPa	- 90 kPa	- 20 kPa	- 60 kPa	- 90 kPa
VF300	820.00	163	438	653	135	307	476

※ The lifting force above does not include safety factor

Material Specifications

Material	Hardness Shore (°)	Color	Temperature (°C)
NBR	60	Black	-20~110
Silicone	55	Red	-70~200
White Silicone	55	Translucent White	-70~200
White Silicone (FDA)	55	Translucent White	-70~200
High temp. Silicone	50	Blue	-70~280
Conductive Silicone	70	Smoky Black	-45~90
Urethane	60	Dark Green	0~100
Mark Free	75	Black	-10~100

Material Resistance

Description	NBR	Silicone	White Silicone	High temp. Silicone	Conductive Silicone	Urethane	Mark Free
Wear Resistance	Excellent	Good	Good	Good	Good	Excellent	Good
Oil	Excellent	Poor	Poor	Poor	Poor	Excellent	Excellent
Weather / Ozone	Fair	Excellent	Excellent	Excellent	Excellent	Excellent	Excellent
Alcohol	Good	Good	Good	Good	Good	Fair	Good
Acid	Fair	Poor	Poor	Poor	Poor	Poor	Excellent

Dimension

[Unit : mm]

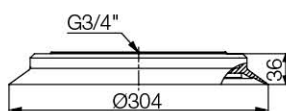

[With 34F fitting]

Build an Ordering No.

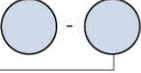
VF300 -  : Pre-mounted fitting
 1. Suction Cup

1. Suction cup	Description	Weight (g)	Symbol
	Flat suction cup, 300mm diameter, Nitrile (NBR), G3/4 female fitting	2677	VF300-N-34F
	Flat suction cup, 300mm diameter, Silicone, G3/4 female fitting	2646.37	VF300-S-34F
	Flat suction cup, 300mm diameter, White silicone, G3/4 female fitting	2670.15	VF300-WS-34F
	Flat suction cup, 300mm diameter, White silicone (FDA), G3/4 female fitting	2670.15	VF300-WS-34F (FDA)
	Flat suction cup, 300mm diameter, High temperature silicone, G3/4 female fitting	2768.28	VF300-HS-34F
	Flat suction cup, 300mm diameter, Conductive silicone , G3/4 female fitting	2651.03	VF300-CS-34F
	Flat suction cup, 300mm diameter, Urethane, G3/4 female fitting	2773.37	VF300-U-34F
	Flat suction cup, 300mm diameter, Mark free, G3/4 female fitting	2842.23	VF300-A-34F