

SUCTION CUPS / Long Multi Bellows

VBL Series

Application

Widely cover for increased degree of height compensation
Excellent for fragile products

Advantages

Particularly good for use on curved surfaces and for separating thin sheets of materials in stacks with long bellows
Can cope with an increased degree of height compensation and is particularly good for handling fragile objects
The bellows cup is very good at compensating for a degree of difference in level and curvature of the work piece

| Application



Examples of use

Fragile objects, General food products,
Glass, Eggs, Bread

| Available size options

Model	Description	Model	Description
VBL10	Long multi-bellow suction cup Ø10	VBL35M	Long multi-bellow suction cup Ø35
VBL15	Long multi-bellow suction cup Ø15	VBL40	Long multi-bellow suction cup Ø40
VBL20	Long multi-bellow suction cup Ø20	VBL40B	Long multi-bellow suction cup Ø40
VBL30	Long multi-bellow suction cup Ø30	VBL50	Long multi-bellow suction cup Ø50



I Recommended Lifting Force (Max.)

Model	Volume (cm ³)	Lifting Force (Kg) - Perpendicular		Page
		- 20 kPa	- 60 kPa	
VBL10	0.54	0.15	0.34	220
VBL15	1.95	0.30	0.60	222
VBL20	4.00	0.40	0.90	224
VBL30	13.00	0.90	2.20	226
VBL35M	21.00	1.20	3.30	228
VBL40	27.00	1.40	3.60	230
VBL40B	26.00	1.90	4.30	232
VBL50	55.00	2.50	6.00	234

※ The lifting force above does not include safety factor

SUCTION CUPS / Long Multi Bellows

VBL10

Features and Strengths

Widely cover for increased degree of height compensation
Excellent for fragile products

Examples of use

Fragile objects, General food products
Glass, Metal ball, Plastic bag, Bread



Recommended Lifting Force (Max.)

Model	Volume (cm ³)	Lifting Force (Kg) - Perpendicular	
		- 20 kPa	- 60 kPa
VBL10	0.54	0.15	0.34

※ The lifting force above does not include safety factor

Material Specifications

Material	Hardness Shore (°)	Color	Temperature (°C)
NBR	60	Black	-20~110
Silicone	55	Red	-70~200
White Silicone	55	Translucent White	-70~200
White Silicone (FDA)	55	Translucent White	-70~200
High temp. Silicone	50	Blue	-70~280
Conductive Silicone	70	Smoky Black	-45~90
Urethane	60	Dark Green	0~100
Mark Free	75	Black	-10~100

※ For additional material, see page 32~33

Material Resistance

Description	NBR	Silicone	White Silicone	High temp. Silicone	Conductive Silicone	Urethane	Mark Free
Wear Resistance	Excellent	Good	Good	Good	Good	Excellent	Good
Oil	Excellent	Poor	Poor	Poor	Poor	Excellent	Excellent
Weather / Ozone	Fair	Excellent	Excellent	Excellent	Excellent	Excellent	Excellent
Alcohol	Good	Good	Good	Good	Good	Fair	Good
Acid	Fair	Poor	Poor	Poor	Poor	Poor	Excellent

Build an Ordering No.

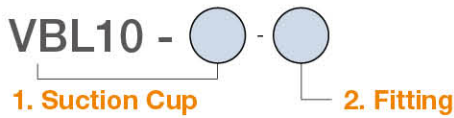

1. Suction cup	Description	Symbol
	Long multi-bellow suction cup, 10mm diameter, Nitrile (NBR)	VBL10-N
	Long multi-bellow suction cup, 10mm diameter, Silicone	VBL10-S
	Long multi-bellow suction cup, 10mm diameter, White silicone	VBL10-WS
	Long multi-bellow suction cup, 10mm diameter, White silicone (FDA)	VBL10-WS(FDA)
	Long multi-bellow suction cup, 10mm diameter, High temperature silicone	VBL10-HS
	Long multi-bellow suction cup, 10mm diameter, Conductive silicone	VBL10-CS
	Long multi-bellow suction cup, 10mm diameter, Urethane	VBL10-U
	Long multi-bellow suction cup, 10mm diameter, Mark free	VBL10-A
2. Fitting	Description	Symbol
	Fitting, M5 male	M5M
	Efficiency valve, Fitting, M5 male	M5M-EV

Spare Parts – Rubber Parts

Part No.	Description	Weight (g)	Color
VBL10-N	Long multi-bellow suction cup, 10mm diameter, Nitrile (NBR)	0.66	Black
VBL10-S	Long multi-bellow suction cup, 10mm diameter, Silicone	0.62	Red
VBL10-WS	Long multi-bellow suction cup, 10mm diameter, White silicone	0.55	Translucent White
VBL10-WS(FDA)	Long multi-bellow suction cup, 10mm diameter, White silicone (FDA)	0.55	Translucent White
VBL10-HS	Long multi-bellow suction cup, 10mm diameter, High temperature silicone	0.58	Blue
VBL10-CS	Long multi-bellow suction cup, 10mm diameter, Conductive silicone	0.63	Smoky Black
VBL10-U	Long multi-bellow suction cup, 10mm diameter, Urethane	0.59	Dark Green
VBL10-A	Long multi-bellow suction cup, 10mm diameter, Mark free	0.63	Black

Spare Parts – Fittings

Part No. (Code No.)	Fitting size	Description	Weight (g)
350 000 3102	M5M	M5 male	2.52
350 010 3102	M5M-EV	Efficiency valve, M5 male	2.63

SUCTION CUPS / Long Multi Bellows

VBL15

Features and Strengths

Widely cover for increased degree of height compensation
Excellent for fragile products

Examples of use

Fragile objects, General food products
Glass, Metal ball, Plastic bag, Bread



Recommended Lifting Force (Max.)

Model	Volume (cm ³)	Lifting Force (Kg) - Perpendicular	
		- 20 kPa	- 60 kPa
VBL15	1.95	0.30	0.60

※ The lifting force above does not include safety factor

Material Specifications

Material	Hardness Shore (°)	Color	Temperature (°C)
NBR	60	Black	-20~110
Silicone	55	Red	-70~200
White Silicone	55	Translucent White	-70~200
White Silicone (FDA)	55	Translucent White	-70~200
High temp. Silicone	50	Blue	-70~280
Conductive Silicone	70	Smoky Black	-45~90
Urethane	60	Dark Green	0~100
Mark Free	75	Black	-10~100

※ For additional material, see page 32~33

Material Resistance

Description	NBR	Silicone	White Silicone	High temp. Silicone	Conductive Silicone	Urethane	Mark Free
Wear Resistance	Excellent	Good	Good	Good	Good	Excellent	Good
Oil	Excellent	Poor	Poor	Poor	Poor	Excellent	Excellent
Weather / Ozone	Fair	Excellent	Excellent	Excellent	Excellent	Excellent	Excellent
Alcohol	Good	Good	Good	Good	Good	Fair	Good
Acid	Fair	Poor	Poor	Poor	Poor	Poor	Excellent

Dimension

[Unit : mm]

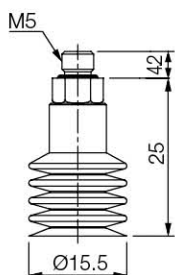

[With M5M fitting]

I Build an Ordering No.

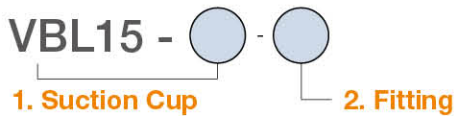

1. Suction cup	Description	Symbol
	Long multi-bellows suction cup, 15mm diameter, Nitrile (NBR)	VBL15-N
	Long multi-bellows suction cup, 15mm diameter, Silicone	VBL15-S
	Long multi-bellows suction cup, 15mm diameter, White silicone	VBL15-WS
	Long multi-bellows suction cup, 15mm diameter, White silicone (FDA)	VBL15-WS(FDA)
	Long multi-bellows suction cup, 15mm diameter, High temperature silicone	VBL15-HS
	Long multi-bellows suction cup, 15mm diameter, Conductive silicone	VBL15-CS
	Long multi-bellows suction cup, 15mm diameter, Urethane	VBL15-U
	Long multi-bellows suction cup, 15mm diameter, Mark free	VBL15-A

2. Fitting	Description	Symbol
	Fitting, M5 male	M5M
	Efficiency valve, Fitting, M5 male	M5M-EV

I Spare Parts – Rubber Parts

Part No.	Description	Weight (g)	Color
VBL15-N	Long multi-bellows suction cup, 15mm diameter, Nitrile (NBR)	1.33	Black
VBL15-S	Long multi-bellows suction cup, 15mm diameter, Silicone	1.18	Red
VBL15-WS	Long multi-bellows suction cup, 15mm diameter, White silicone	1.22	Translucent White
VBL15-WS(FDA)	Long multi-bellows suction cup, 15mm diameter, White silicone (FDA)	1.22	Translucent White
VBL15-HS	Long multi-bellows suction cup, 15mm diameter, High temperature silicone	1.33	Blue
VBL15-CS	Long multi-bellows suction cup, 15mm diameter, Conductive silicone	1.36	Smoky Black
VBL15-U	Long multi-bellows suction cup, 15mm diameter, Urethane	1.24	Dark Green
VBL15-A	Long multi-bellows suction cup, 15mm diameter, Mark free	1.51	Black

[Unit : mm]

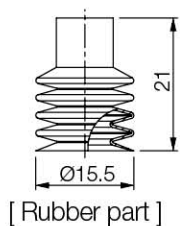

I Spare Parts – Fittings

Part No. (Code No.)	Fitting size	Description	Weight (g)
350 000 3102	M5M	M5 male	2.52
350 010 3102	M5M-EV	Efficiency valve, M5 male	2.63

SUCTION CUPS / Long Multi Bellows

VBL20

Features and Strengths

Widely cover for increased degree of height compensation
Excellent for fragile products

Examples of use

Fragile objects, General food products
Glass, Eggs, Bread



Recommended Lifting Force (Max.)

Model	Volume (cm ³)	Lifting Force (Kg) - Perpendicular	
		- 20 kPa	- 60 kPa
VBL20	4.00	0.40	0.90

※ The lifting force above does not include safety factor

Material Specifications

Material	Hardness Shore (°)	Color	Temperature (°C)
NBR	60	Black	-20~110
Silicone	55	Red	-70~200
White Silicone	55	Translucent White	-70~200
White Silicone (FDA)	55	Translucent White	-70~200
High temp. Silicone	50	Blue	-70~280
Conductive Silicone	70	Smoky Black	-45~90
Urethane	60	Dark Green	0~100
Mark Free	75	Black	-10~100

※ For additional material, see page 32~33

Material Resistance

Description	NBR	Silicone	White Silicone	High temp. Silicone	Conductive Silicone	Urethane	Mark Free
Wear Resistance	Excellent	Good	Good	Good	Good	Excellent	Good
Oil	Excellent	Poor	Poor	Poor	Poor	Excellent	Excellent
Weather / Ozone	Fair	Excellent	Excellent	Excellent	Excellent	Excellent	Excellent
Alcohol	Good	Good	Good	Good	Good	Fair	Good
Acid	Fair	Poor	Poor	Poor	Poor	Poor	Excellent

Dimension

[Unit : mm]

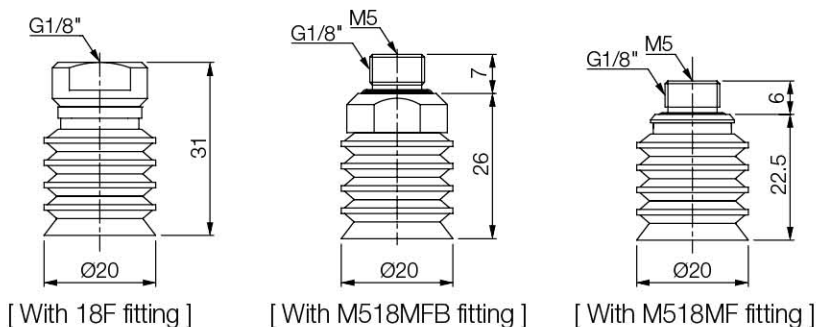

I Build an Ordering No.

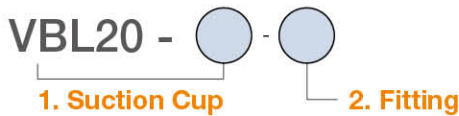

1. Suction cup	Description	Symbol
	Long multi-bellows suction cup, 20mm diameter, Nitrile (NBR)	VBL20-N
	Long multi-bellows suction cup, 20mm diameter, Silicone	VBL20-S
	Long multi-bellows suction cup, 20mm diameter, White silicone	VBL20-WS
	Long multi-bellows suction cup, 20mm diameter, White silicone (FDA)	VBL20-WS(FDA)
	Long multi-bellows suction cup, 20mm diameter, High temperature silicone	VBL20-HS
	Long multi-bellows suction cup, 20mm diameter, Conductive silicone	VBL20-CS
	Long multi-bellows suction cup, 20mm diameter, Urethane	VBL20-U
	Long multi-bellows suction cup, 20mm diameter, Mark free	VBL20-A

2. Fitting	Description	Symbol
	Fitting, G1/8 male - M5 female	M518MF
	Fitting, G1/8 male - M5 female, Mesh filter	M-M518MF
	Efficiency valve, Fitting, G1/8 male - M5 female	M518MF-EV
	Fitting, G1/8 male - M5 female, Old profile	M518MFO
	Fitting, G1/8 male - M5 female, Old profile, Mesh filter	M-M518MFO
	Efficiency valve, Fitting, G1/8 male - M5 female, Old profile	M518MFO-EV
	Fitting, G1/8 male - M5 female, For silicone material	M518MFB*
	Fitting, G1/8 female	18F
	Fitting, G1/8 female, Mesh filter	M-18F
	Efficiency valve, Fitting, G1/8 Female	18F-EV

* M518MFB is available only for Silicone material.

I Spare Parts – Rubber Parts

Part No.	Description	Weight (g)	Color
VBL20-N	Long multi-bellows suction cup, 20mm diameter, Nitrile (NBR)	2.22	Black
VBL20-S	Long multi-bellows suction cup, 20mm diameter, Silicone	2.00	Red
VBL20-WS	Long multi-bellows suction cup, 20mm diameter, White silicone	2.00	Translucent White
VBL20-WS(FDA)	Long multi-bellows suction cup, 20mm diameter, White silicone (FDA)	2.00	Translucent White
VBL20-HS	Long multi-bellows suction cup, 20mm diameter, High temperature silicone	2.11	Blue
VBL20-CS	Long multi-bellows suction cup, 20mm diameter, Conductive silicone	2.08	Smoky Black
VBL20-U	Long multi-bellows suction cup, 20mm diameter, Urethane	1.98	Dark Green
VBL20-A	Long multi-bellows suction cup, 20mm diameter, Mark free	2.52	Black

[Unit : mm]

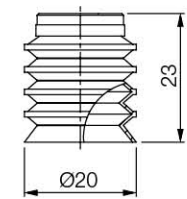

[Rubber part]

I Spare Parts – Fittings

Part No. (Code No.)	Fitting size	Description	Weight (g)
350 000 3209	M518MF	G1/8 male - M5 female	1.82
350 000 5209	M518MF-F	G1/8 male - M5 female, Mesh filter	1.92
350 010 4209	M518MF-EV	Efficiency valve, G1/8 male - M5 female	1.94
350 000 1209	M518MFO	G1/8 male - M5 female, Old profile	2.88
350 000 1109	M518MFO-F	G1/8 male - M5 female, Old profile, Mesh filter	2.94
350 010 1209	M518MFO-EV	Efficiency valve, G1/8 male - M5 female, Old profile	2.87
350 000 3239	M518MFB	G1/8 male - M5 female, For silicone material	3.56
350 000 3310	18F	G1/8 female	3.20
350 000 4310	18F-F	G1/8 female, Mesh filter	3.26
350 010 3310	18F-EV	Efficiency valve, G1/8 Female	3.31

SUCTION CUPS / Long Multi Bellows

VBL30

Features and Strengths

Widely cover for increased degree of height compensation
Excellent for fragile products

Examples of use

Fragile objects, General food products
Glass, Eggs, Bread



Recommended Lifting Force (Max.)

Model	Volume (cm ³)	Lifting Force (Kg) - Perpendicular	
		- 20 kPa	- 60 kPa
VBL30	13.00	0.90	2.20

※ The lifting force above does not include safety factor

Material Specifications

Material	Hardness Shore (°)	Color	Temperature (°C)
NBR	60	Black	-20~110
Silicone	55	Red	-70~200
White Silicone	55	Translucent White	-70~200
White Silicone (FDA)	55	Translucent White	-70~200
High temp. Silicone	50	Blue	-70~280
Conductive Silicone	70	Smoky Black	-45~90
Urethane	60	Dark Green	0~100
Mark Free	75	Black	-10~100

※ For additional material, see page 32~33

Material Resistance

Description	NBR	Silicone	White Silicone	High temp. Silicone	Conductive Silicone	Urethane	Mark Free
Wear Resistance	Excellent	Good	Good	Good	Good	Excellent	Good
Oil	Excellent	Poor	Poor	Poor	Poor	Excellent	Excellent
Weather / Ozone	Fair	Excellent	Excellent	Excellent	Excellent	Excellent	Excellent
Alcohol	Good	Good	Good	Good	Good	Fair	Good
Acid	Fair	Poor	Poor	Poor	Poor	Poor	Excellent

Dimension

[Unit : mm]

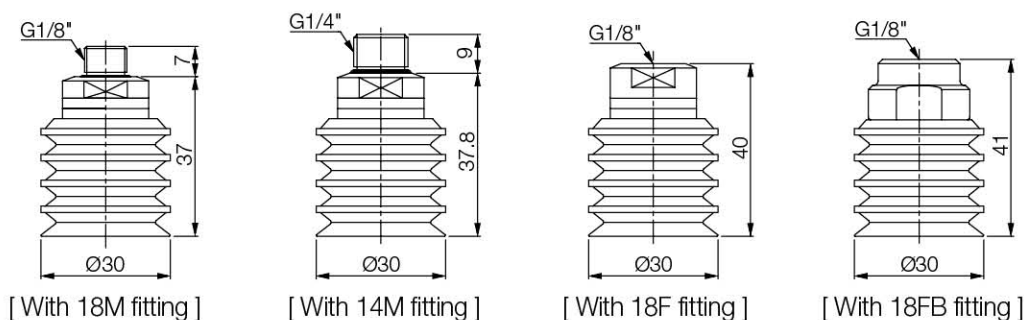

Build an Ordering No.

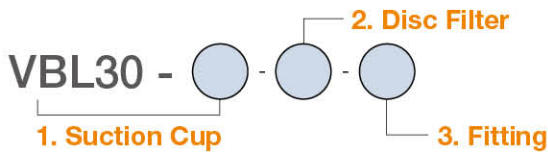

1. Suction cup	Description	Symbol
	Long multi-bellows suction cup, 30mm diameter, Nitrile (NBR)	VBL30-N
	Long multi-bellows suction cup, 30mm diameter, Silicone	VBL30-S
	Long multi-bellows suction cup, 30mm diameter, White silicone	VBL30-WS
	Long multi-bellows suction cup, 30mm diameter, White silicone (FDA)	VBL30-WS(FDA)
	Long multi-bellows suction cup, 30mm diameter, High temperature silicone	VBL30-HS
	Long multi-bellows suction cup, 30mm diameter, Conductive silicone	VBL30-CS
	Long multi-bellows suction cup, 30mm diameter, Urethane	VBL30-U
	Long multi-bellows suction cup, 30mm diameter, Mark free	VBL30-A
2. Disc Filter	Description	Symbol
	No disc filter	Blank
	Disc filter, Polyethylene	F
3. Fitting	Description	Symbol
	Fitting, G1/8 female	18F
	Fitting, G1/8 female, Mesh filter	M-18F
	Efficiency valve, Fitting, G1/8 female	18F-EV
	Fitting, G1/8 female, For silicone material	18FB*
	Fitting, G1/8 female, Old profile	18FO
	Fitting, G1/8 female, Old profile, Mesh filter	M-18FO
	Fitting, G1/8 male	18M
	Fitting, G1/8 male, Mesh filter	M-18M
	Efficiency valve, Fitting, G1/8 male	18M-EV
	Fitting, G1/4 male	14M
	Fitting, G1/4 male, Mesh filter	M-14M
	Efficiency valve, Fitting, G1/4 male	14M-EV

* 18FB is available only for Silicone material.

Spare Parts – Rubber Parts

Part No.	Description	Weight (g)	Color
VBL30-N	Long multi-bellows suction cup, 30mm diameter, Nitrile (NBR)	6.39	Black
VBL30-S	Long multi-bellows suction cup, 30mm diameter, Silicone	5.26	Red
VBL30-WS	Long multi-bellows suction cup, 30mm diameter, White silicone	5.65	Translucent White
VBL30-WS(FDA)	Long multi-bellows suction cup, 30mm diameter, White silicone (FDA)	5.65	Translucent White
VBL30-HS	Long multi-bellows suction cup, 30mm diameter, High temperature silicone	6.38	Blue
VBL30-CS	Long multi-bellows suction cup, 30mm diameter, Conductive silicone	5.44	Smoky Black
VBL30-U	Long multi-bellows suction cup, 30mm diameter, Urethane	5.96	Dark Green
VBL30-A	Long multi-bellows suction cup, 30mm diameter, Mark free	7.25	Black

[Unit : mm]

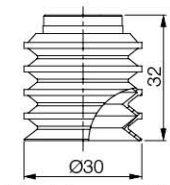

[Rubber part]

Spare Parts – Disc Filter

Part No.	Description	Weight (g)
VTFE-BL30	Disc filter, Polyethylene	0.53

Spare Parts – Fittings

Part No. (Code No.)	Fitting size	Description	Weight (g)
350 000 3311	18F	G1/8 female	5.68
350 000 4311	18F-F	G1/8 female, Mesh filter	5.73
350 010 3311	18F-EV	Efficiency valve, G1/8 female	5.63
350 000 3331	18FB	G1/8 female, For silicone material	9.78
350 000 2311	18FO	G1/8 female, Old profile	8.24
350 000 4811	18FO-F	G1/8 female, Old profile, Mesh filter	8.41
350 000 2304	18M	G1/8 male	4.93
350 000 4304	18M-F	G1/8 male, Mesh filter	5.04
350 010 2304	18M-EV	Efficiency valve, G1/8 male	5.08
350 000 3404	14M	G1/4 male	5.88
350 000 3804	14M-F	G1/4 male, Mesh filter	5.92
350 010 3404	14M-EV	Efficiency valve, G1/4 male	6.03

SUCTION CUPS / Long Multi Bellows

VBL35M



Features and Strengths

Widely cover for increased degree of height compensation with direct fitting
Excellent for fragile products

Examples of use

Fragile objects, General food products
Glass, Eggs, Bread



Recommended Lifting Force (Max.)

Model	Volume (cm ³)	Lifting Force (Kg) - Perpendicular	
		- 20 kPa	- 60 kPa
VBL35M	21.00	1.20	3.30

※ The lifting force above does not include safety factor

Material Specifications

Material	Hardness Shore (°)	Color	Temperature (°C)
NBR	60	Black	-20~110
Silicone	55	Red	-70~200
White Silicone	55	Translucent White	-70~200
White Silicone (FDA)	30	Translucent White	-70~200
White Silicone (FDA)	55	Translucent White	-70~200
High temp. Silicone	50	Blue	-70~280
Conductive Silicone	70	Smoky Black	-45~90
Urethane	60	Dark Green	0~100
Mark Free	75	Black	-10~100

※ For additional material, see page 32~33

Material Resistance

Description	NBR	Silicone	White Silicone	High temp. Silicone	Conductive Silicone	Urethane	Mark Free
Wear Resistance	Excellent	Good	Good	Good	Good	Excellent	Good
Oil	Excellent	Poor	Poor	Poor	Poor	Excellent	Excellent
Weather / Ozone	Fair	Excellent	Excellent	Excellent	Excellent	Excellent	Excellent
Alcohol	Good	Good	Good	Good	Good	Fair	Good
Acid	Fair	Poor	Poor	Poor	Poor	Poor	Excellent

Build an Ordering No.

VBL35M - 

1. Suction Cup

1. Suction cup	Description	Weight (g)	Symbol
	Long multi-bellows suction cup, 35mm diameter, Pipe mount neck, Nitrile (NBR)	19.34	VBL35M-N
	Long multi-bellows suction cup, 35mm diameter, Pipe mount neck, Silicone	17.80	VBL35M-S
	Long multi-bellows suction cup, 35mm diameter, Pipe mount neck, White silicone	17.78	VBL35M-WS
	Long multi-bellow suction cup, 35mm diameter, Pipe mount neck, White silicone 30°(FDA)	17.78	VBL35M-WS(FDA)
	Long multi-bellow suction cup, 35mm diameter, Pipe mount neck, White silicone 55°(FDA)	17.78	VBL35M-WS(FDA)
	Long multi-bellows suction cup, 35mm diameter, Pipe mount neck, High temperature silicone	19.33	VBL35M-HS
	Long multi-bellows suction cup, 35mm diameter, Pipe mount neck, Conductive silicone	16.78	VBL35M-CS
	Long multi-bellows suction cup, 35mm diameter, Pipe mount neck, Urethane	18	VBL35M-U
	Long multi-bellows suction cup, 35mm diameter, Pipe mount neck, Mark free	21.44	VBL35M-A

[Unit : mm]

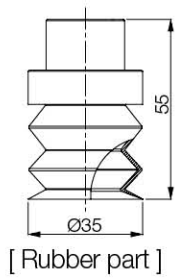

SUCTION CUPS / Long Multi Bellows

VBL40

Features and Strengths

Widely cover for increased degree of height compensation
Excellent for fragile products

Examples of use

Fragile objects, General food products
Glass, Eggs, Bread



Recommended Lifting Force (Max.)

Model	Volume (cm ³)	Lifting Force (Kg) - Perpendicular	
		- 20 kPa	- 60 kPa
VBL40	27.00	1.40	3.60

※ The lifting force above does not include safety factor

Material Specifications

Material	Hardness Shore (°)	Color	Temperature (°C)
NBR	60	Black	-20~110
Silicone	55	Red	-70~200
White Silicone	55	Translucent White	-70~200
White Silicone (FDA)	55	Translucent White	-70~200
High temp. Silicone	50	Blue	-70~280
Conductive Silicone	70	Smoky Black	-45~90
Urethane	60	Dark Green	0~100
Mark Free	75	Black	-10~100

※ For additional material, see page 32~33

Material Resistance

Description	NBR	Silicone	White Silicone	High temp. Silicone	Conductive Silicone	Urethane	Mark Free
Wear Resistance	Excellent	Good	Good	Good	Good	Excellent	Good
Oil	Excellent	Poor	Poor	Poor	Poor	Excellent	Excellent
Weather / Ozone	Fair	Excellent	Excellent	Excellent	Excellent	Excellent	Excellent
Alcohol	Good	Good	Good	Good	Good	Fair	Good
Acid	Fair	Poor	Poor	Poor	Poor	Poor	Excellent

Dimension

[Unit : mm]

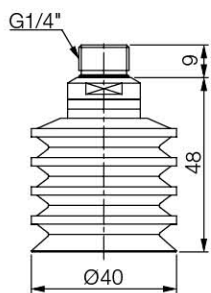

[With 14M fitting]

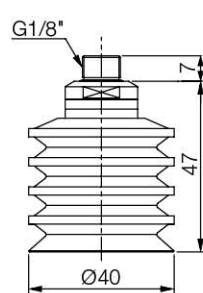

[With 18M fitting]

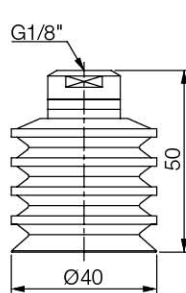

[With 18F fitting]

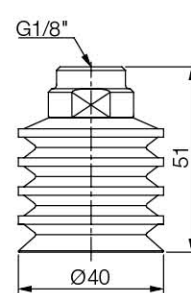

[With 18FB fitting]

Build an Ordering No.

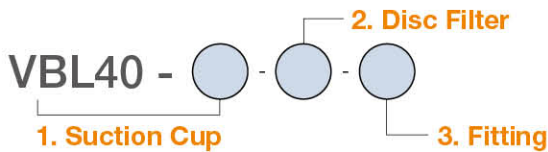

1. Suction cup	Description	Symbol
	Long multi-bellows suction cup, 40mm diameter, Nitrile (NBR)	VBL40-N
	Long multi-bellows suction cup, 40mm diameter, Silicone	VBL40-S
	Long multi-bellows suction cup, 40mm diameter, White silicone	VBL40-WS
	Long multi-bellows suction cup, 40mm diameter, White silicone (FDA)	VBL40-WS(FDA)
	Long multi-bellows suction cup, 40mm diameter, High temperature silicone	VBL40-HS
	Long multi-bellows suction cup, 40mm diameter, Conductive silicone	VBL40-CS
	Long multi-bellows suction cup, 40mm diameter, Urethane	VBL40-U
	Long multi-bellows suction cup, 40mm diameter, Mark free	VBL40-A
2. Disc Filter	Description	Symbol
	No disc filter	Blank
	Disc filter, Polyethylene	F
3. Fitting	Description	Symbol
	Fitting, G1/8 female	18F
	Fitting, G1/8 female, Mesh filter	M-18F
	Efficiency valve, Fitting, G1/8 female	18F-EV
	Fitting, G1/8 female, For silicone material	18FB*
	Fitting, G1/8 female, Old profile	18FO
	Fitting, G1/8 female, Old profile, Mesh filter	M-18FO
	Fitting, G1/8 male	18M
	Fitting, G1/8 male, Mesh filter	M-18M
	Efficiency valve, Fitting, G1/8 male	18M-EV
	Fitting, G1/4 male	14M
	Fitting, G1/4 male, Mesh filter	M-14M
	Efficiency valve, Fitting, G1/4 male	14M-EV

* 18FB is available only for Silicone material.

Spare Parts – Rubber Parts

Part No.	Description	Weight (g)	Color
VBL40-N	Long multi-bellows suction cup, 40mm diameter, Nitrile (NBR)	12.08	Black
VBL40-S	Long multi-bellows suction cup, 40mm diameter, Silicone	11.42	Red
VBL40-WS	Long multi-bellows suction cup, 40mm diameter, White silicone	11.31	Translucent White
VBL40-WS(FDA)	Long multi-bellows suction cup, 40mm diameter, White silicone (FDA)	11.31	Translucent White
VBL40-HS	Long multi-bellows suction cup, 40mm diameter, High temperature silicone	11.38	Blue
VBL40-CS	Long multi-bellows suction cup, 40mm diameter, Conductive silicone	11.39	Smoky Black
VBL40-U	Long multi-bellows suction cup, 40mm diameter, Urethane	12.99	Dark Green
VBL40-A	Long multi-bellows suction cup, 40mm diameter, Mark free	13.09	Black

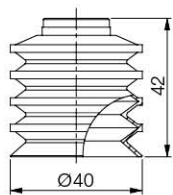

[Rubber part]

[Unit : mm]

Spare Parts – Disc Filter

Part No.	Description	Weight (g)
VTFE-BL40	Disc filter, Polyethylene	0.87

Spare Parts – Fittings

Part No. (Code No.)	Fitting size	Description	Weight (g)
350 000 3311	18F	G1/8 female	5.68
350 000 4311	18F-F	G1/8 female, Mesh filter	5.73
350 010 3311	18F-EV	Efficiency valve, G1/8 female	5.63
350 000 3331	18FB	G1/8 female, For silicone material	9.78
350 000 2311	18FO	G1/8 female, Old profile	8.24
350 000 4811	18FO-F	G1/8 female, Old profile, Mesh filter	8.41
350 000 2304	18M	G1/8 male	4.93
350 000 4304	18M-F	G1/8 male, Mesh filter	5.04
350 010 2304	18M-EV	Efficiency valve, G1/8 male	5.08
350 000 3404	14M	G1/4 male	5.88
350 000 3804	14M-F	G1/4 male, Mesh filter	5.92
350 010 3404	14M-EV	Efficiency valve, G1/4 male	6.03

SUCTION CUPS / Long Multi Bellows

VBL40B



Features and Strengths

Widely cover for increased degree of height compensation with direct fitting
Excellent for fragile products

Examples of use

Fragile objects, General food products
Glass, Eggs, Bread

Recommended Lifting Force (Max.)

Model	Volume (cm ³)	Lifting Force (Kg) - Perpendicular	
		- 20 kPa	- 60 kPa
VBL40B	26.00	1.90	4.30

※ The lifting force above does not include safety factor

Material Specifications

Material	Hardness Shore (°)	Color	Temperature (°C)
NBR	60	Black	-20~110
Silicone	55	Red	-70~200
White Silicone	55	Translucent White	-70~200
White Silicone (FDA)	30	Translucent White	-70~200
White Silicone (FDA)	55	Translucent White	-70~200
High temp. Silicone	50	Blue	-70~280
Conductive Silicone	70	Smoky Black	-45~90
Urethane	60	Dark Green	0~100
Mark Free	75	Black	-10~100

※ For additional material, see page 32~33

Material Resistance

Description	NBR	Silicone	White Silicone	High temp. Silicone	Conductive Silicone	Urethane	Mark Free
Wear Resistance	Excellent	Good	Good	Good	Good	Excellent	Good
Oil	Excellent	Poor	Poor	Poor	Poor	Excellent	Excellent
Weather / Ozone	Fair	Excellent	Excellent	Excellent	Excellent	Excellent	Excellent
Alcohol	Good	Good	Good	Good	Good	Fair	Good
Acid	Fair	Poor	Poor	Poor	Poor	Poor	Excellent

I Build an Ordering No.

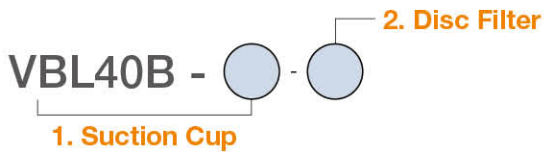

1. Suction cup	Description	Symbol
	Long multi-bellows suction cup, 40mm diameter, Nitrile (NBR)	VBL40B-N
	Long multi-bellows suction cup, 40mm diameter, Silicone	VBL40B-S
	Long multi-bellows suction cup, 40mm diameter, White silicone	VBL40B-WS
	Long multi-bellow suction cup, 40mm diameter, White silicone 30° (FDA)	VBL40-WS(FDA)
	Long multi-bellow suction cup, 40mm diameter, White silicone 55° (FDA)	VBL40-WS(FDA)
	Long multi-bellows suction cup, 40mm diameter, High temperature silicone	VBL40B-HS
	Long multi-bellows suction cup, 40mm diameter, Conductive silicone	VBL40B-CS
	Long multi-bellows suction cup, 40mm diameter, Urethane	VBL40B-U
	Long multi-bellows suction cup, 40mm diameter, Mark free	VBL40B-A
2. Disc Filter	Description	Symbol
	No disc filter	Blank
	Disc filter, Polyethylene	F

I Spare Parts – Rubber Parts

Part No.	Description	Weight (g)	Color
VBL40B-N	Long multi-bellows suction cup, 40mm diameter, Nitrile (NBR)	9.87	Black
VBL40B-S	Long multi-bellows suction cup, 40mm diameter, Silicone	8.23	Red
VBL40B-WS	Long multi-bellows suction cup, 40mm diameter, White silicone	8.11	Translucent White
VBL40-WS 30(FDA)	Long multi-bellow suction cup, 40mm diameter, White silicone 30° (FDA)	11.31	Translucent White
VBL40-WS 55(FDA)	Long multi-bellow suction cup, 40mm diameter, White silicone 55° (FDA)	11.31	Translucent White
VBL40B-HS	Long multi-bellows suction cup, 40mm diameter, High temperature silicone	9.29	Blue
VBL40B-CS	Long multi-bellows suction cup, 40mm diameter, Conductive silicone	9.35	Smoky Black
VBL40B-U	Long multi-bellows suction cup, 40mm diameter, Urethane	10.51	Dark Green
VBL40B-A	Long multi-bellows suction cup, 40mm diameter, Mark free	10.69	Black

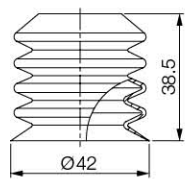

[Rubber part]

[Unit : mm]

I Spare Parts – Disc Filter

Part No.	Description	Weight (g)
VTFE-BL40B	Disc filter, Polyethylene	0.87

SUCTION CUPS / Long Multi Bellows

VBL50

Features and Strengths

Widely cover for increased degree of height compensation
Excellent for fragile products

Examples of use

Fragile objects, General food products
Glass, Eggs, Bread



Recommended Lifting Force (Max.)

Model	Volume (cm ³)	Lifting Force (Kg) - Perpendicular	
		- 20 kPa	- 60 kPa
VBL50	55.00	2.50	6.00

※ The lifting force above does not include safety factor

Material Specifications

Material	Hardness Shore (°)	Color	Temperature (°C)
NBR	60	Black	-20~110
Silicone	55	Red	-70~200
White Silicone	55	Translucent White	-70~200
White Silicone (FDA)	55	Translucent White	-70~200
High temp. Silicone	50	Blue	-70~280
Conductive Silicone	70	Smoky Black	-45~90
Urethane	60	Dark Green	0~100
Mark Free	75	Black	-10~100

※ For additional material, see page 32~33

Material Resistance

Description	NBR	Silicone	White Silicone	High temp. Silicone	Conductive Silicone	Urethane	Mark Free
Wear Resistance	Excellent	Good	Good	Good	Good	Excellent	Good
Oil	Excellent	Poor	Poor	Poor	Poor	Excellent	Excellent
Weather / Ozone	Fair	Excellent	Excellent	Excellent	Excellent	Excellent	Excellent
Alcohol	Good	Good	Good	Good	Good	Fair	Good
Acid	Fair	Poor	Poor	Poor	Poor	Poor	Excellent

Dimension

[Unit : mm]

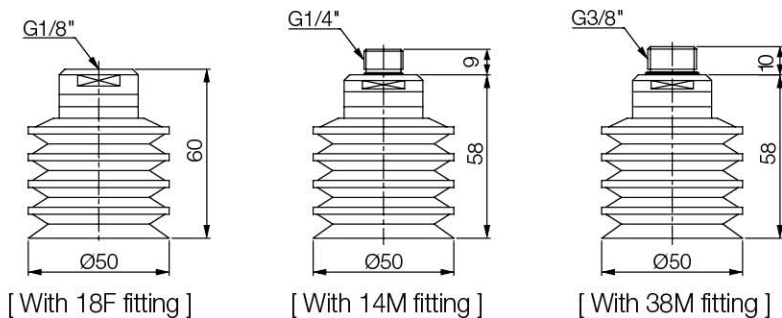

I Build an Ordering No.

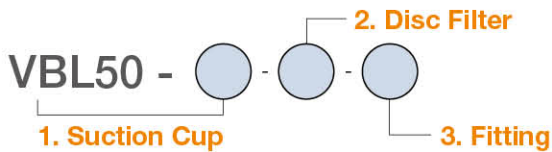

1. Suction cup	Description	Symbol
	Long multi-bellows suction cup, 50mm diameter, Nitrile (NBR)	VBL50-N
	Long multi-bellows suction cup, 50mm diameter, Silicone	VBL50-S
	Long multi-bellows suction cup, 50mm diameter, White silicone	VBL50-WS
	Long multi-bellows suction cup, 50mm diameter, White silicone (FDA)	VBL50-WS(FDA)
	Long multi-bellows suction cup, 50mm diameter, High temperature silicone	VBL50-HS
	Long multi-bellows suction cup, 50mm diameter, Conductive silicone	VBL50-CS
	Long multi-bellows suction cup, 50mm diameter, Urethane	VBL50-U
	Long multi-bellows suction cup, 50mm diameter, Mark free	VBL50-A
2. Disc Filter	Description	Symbol
	No disc filter	Blank
	Disc filter, Polyethylene	F
3. Fitting	Description	Symbol
	Fitting, G1/8 female	18F
	Fitting, G1/8 female, Mesh filter	M-18F
	Efficiency valve, Fitting, G1/8 female	18F-EV
	Fitting, G1/8 female, Old profile	18FO
	Fitting, G1/8 female, Old profile, Mesh filter	M-18FO
	Efficiency valve, Fitting, G1/8 female, Old profile	18FO-EV
	Fitting, G1/4 male	14M
	Fitting, G1/4 male, Mesh filter	M-14M
	Efficiency valve, Fitting, G1/4 male	14M-EV
	Fitting, G3/8 male	38M
	Fitting, G3/8 male, Mesh filter	M-38M
	Efficiency valve, Fitting, G3/8 male	38M-EV

I Spare Parts – Rubber Parts

Part No.	Description	Weight (g)	Color
VBL50-N	Long multi-bellows suction cup, 50mm diameter, Nitrile (NBR)	24.53	Black
VBL50-S	Long multi-bellows suction cup, 50mm diameter, Silicone	21.52	Red
VBL50-WS	Long multi-bellows suction cup, 50mm diameter, White silicone	21.55	Translucent White
VBL50-WS(FDA)	Long multi-bellows suction cup, 50mm diameter, White silicone (FDA)	21.55	Translucent White
VBL50-HS	Long multi-bellows suction cup, 50mm diameter, High temperature silicone	21.51	Blue
VBL50-CS	Long multi-bellows suction cup, 50mm diameter, Conductive silicone	21.59	Smoky Black
VBL50-U	Long multi-bellows suction cup, 50mm diameter, Urethane	26.12	Dark Green
VBL50-A	Long multi-bellows suction cup, 50mm diameter, Mark free	26.56	Black

[Unit : mm]

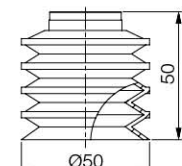

[Rubber part]

I Spare Parts – Disc Filter

Part No.	Description	Weight (g)
VTFE-BL50	Disc filter, Polyethylene	1.34

I Spare Parts – Fittings

Part No. (Code No.)	Fitting size	Description	Weight (g)
350 000 3312	18F	G1/8 female	14.47
350 000 4312	18F-F	G1/8 female, Mesh filter	14.58
350 010 3312	18F-EV	Efficiency valve, G1/8 female	5.81
350 000 1312	18FO	G1/8 female, Old profile	10.12
350 000 4912	18FO-F	G1/8 female, Old profile, Mesh filter	10.2
350 010 1312	18FO-EV	Efficiency valve, G1/8 female, Old profile	10.22
350 000 3405	14M	G1/4 male	14.18
350 000 3805	14M-F	G1/4 male, Mesh filter	14.42
350 010 3405	14M-EV	Efficiency valve, G1/4 male	14.38
350 000 3505	38M	G3/8 male	18.14
350 000 3905	38M-F	G3/8 male, Mesh filter	17.75
350 010 3505	38M-EV	Efficiency valve, G3/8 male	17.53